

Substantial Activities in No or Only Nominal Tax Jurisdictions

Guidance for the Spontaneous Exchange of Information

OCTOBER 2019

**Substantial Activities in No or Only
Nominal Tax Jurisdictions: Additional
Guidance for the Spontaneous Exchange
of Information and Opt-in Notification
Template**

This document, as well as any data and any map included herein, are without prejudice to the status of or sovereignty over any territory, to the delimitation of international frontiers and boundaries and to the name of any territory, city or area.

This document was approved by the OECD/G20 Inclusive Framework on BEPS on 15 October 2019 and prepared for publication by the OECD Secretariat.

Please cite this publication as:

OECD (2019), *Substantial Activities in No or Only Nominal Tax Jurisdictions: Guidance for the Spontaneous Exchange of Information*, OECD, Paris.

www.oecd.org/tax/beps/substantial-activities-in-no-or-only-nominal-tax-jurisdictions-guidance-for-the-spontaneous-exchange-of-information.htm

Photo credits: Cover © metamorworks / Shutterstock.com.

© OECD 2019

You can copy, download or print OECD content for your own use, and you can include excerpts from OECD publications, databases and multimedia products in your own documents, presentations, blogs, websites and teaching materials, provided that suitable acknowledgement of OECD as source and copyright owner is given. All requests for public or commercial use and translation rights should be submitted to rights@oecd.org.

Table of Contents

Abbreviations and acronyms	5
Introduction	7
Part 1 Additional guidance for the exchange of information of no or only nominal tax jurisdictions	9
1. Summary of FHTP standard	11
2. Applicable timelines	13
3. Legal mechanism to operationalise the exchange process	15
4. Key definitions	17
Part 2 NTJ XML Schema	20
1. How the NTJ User Guide links to the NTJ Schema	21
2. NTJ Schema Information	23
3. NTJ Correction examples	45
Annex A. NTJ XML Schema v. 1.0 Diagrams	49
Annex B. Glossary of Namespaces	59
Annex C. Template and instruction sheet for information exchange: cases of non-compliance (jurisdictions with a standard or a fully equipped monitoring mechanism)	60
Annex D. Template and instruction sheet for information exchange: high risk scenarios (standard monitoring mechanism)	65
Annex E. Template and instruction sheet for information exchange: high risk scenarios (fully equipped monitoring mechanism)	69
Annex F. Template and instruction sheet for information exchange: all other cases (standard monitoring mechanism)	72
Annex G. Opt-in notification template	76

Abbreviations and acronyms

BEPS	Base Erosion and Profit Shifting
CA	Competent Authority
CTS	Common Transmission System
FHTP	Forum on Harmful Tax Practices
IP	Intellectual Property
NTJ	Schema for No or Only Nominal Tax Jurisdictions
OECD	Organisation for Economic Co-operation and Development
Standard	FHTP standard on the resumption of the application of the substantial activity factor to no or only nominal tax jurisdictions ¹
UBO	Ultimate Beneficial Owner, as defined for purposes of the Standard
XML	Extendable Mark-up Language

¹ OECD (2018), Resumption of application of substantial activities for no or only nominal tax jurisdictions – BEPS Action 5, OECD, Paris, www.oecd.org/tax/beps/resumption-of-application-of-substantial-activities-factor.pdf

Introduction

The Forum on Harmful Tax Practices (FHTP) agreed at its meeting on 15 – 19 October 2018 on the resumption of the application of the substantial activity factor to no or only nominal tax jurisdictions (hereafter the “Standard”, approved by the Inclusive Framework in November 2018).² The Standard requires no or only nominal tax jurisdictions to exchange information in specified situations. The Standard already includes details as to the circumstances giving rise to exchange, the data points included in the exchange, and the jurisdictions to be exchanged with, summarised in Annex A.

Building on that work, this document addresses the practical modalities regarding the exchange of information requirements of the Standard. **Part 1** contains guidance on the timelines, the international legal framework and clarifications on the key definitions:

- a. **Applicable timelines:** The applicable timeline for conducting the exchanges varies depending on whether the information is exchanged as a result of non-compliance with the substantial activity requirements or in other situations.
- b. **Legal mechanism to operationalise the exchange process:** The exchanges occur as spontaneous exchange of information (SEOI) under the Multilateral Convention on Mutual Administrative Assistance in Tax Matters (the Convention), or where bilateral tax agreements are used, under applicable Tax Information Exchange Agreements or bilateral tax treaties that permit SEOI. In order to operationalise the exchanges, a standardised opt-in template has been developed, by which potential recipient jurisdictions notify their interest in receiving the respective information and that the information is foreseeably relevant for the administration of the recipient jurisdiction’s taxes (see Annex F).
- c. **Key definitions:** Relevant definitions for the exchange framework have been developed.

Part 2 contains the format for the exchanges. The Standard foresees that a standardised template and XML schema will govern the spontaneous exchanges pursuant to the Standard.

The document also includes in Annex A an extract of the Standard relevant to the issues addressed, in Annexes B – E templates for the exchanges which are the basis for the XML Schema and in Annex F the opt-in notification template for the exchanges under the Standard.

² OECD (2018), Resumption of application of substantial activities for no or only nominal tax jurisdictions – BEPS Action 5, OECD, Paris, www.oecd.org/tax/beps/resumption-of-application-of-substantial-activities-factor.pdf

Part 1
*Additional guidance for the exchange of information of no or
only nominal tax jurisdictions*

1. Summary of FHTP standard

1. The FHTP agreed to resume the application of the substantial activity factor for no and only nominal tax jurisdictions for geographically mobile activities, such as financial and other service activities, including the provision of intangibles (hereafter “relevant activities”).

2. No and only nominal tax jurisdictions are therefore expected to have legislation in place requiring entities (the scope of which is to be discussed by the FHTP), conducting relevant activities to meet the substantial activities requirements. This entails conducting the core income generating activities, with an adequate number of full-time employees with necessary qualifications and an adequate amount of operating expenditure, and that such activities are conducted by that entity or within the jurisdiction. The implementation of the Standard by no or only nominal tax jurisdictions is subject to a peer review conducted by the FHTP.

3. In order to ensure compliance with the substantial activity factor, the FHTP agreed that the identified no and only nominal tax jurisdictions should have a monitoring and enforcement mechanism in place to verify the substance requirements of the entities conducting relevant activities. This implies that jurisdictions must collect specific information from the relevant entities in order to identify whether an entity is conducting relevant activities and whether that entity meets the substantial activity requirements as laid out in the Standard.³

4. In addition, the standard requires exchange of information in certain circumstances. The details agreed by the FHTP are reproduced in Annex A, and relate to:

- cases of non-compliance with the substantial activities requirements;
- entities which are exploiting IP assets in circumstances that present a higher risk of not meeting the substantial activity requirements (“high risk cases”); and
- all relevant entities in no or only nominal tax jurisdictions, if such jurisdictions do not have a “fully equipped monitoring mechanism” agreed by the FHTP that provides an effective data collection process and a high-quality review of the substantial activities standard with proactive follow-up where necessary, but instead has the standard monitoring mechanism.

5. The FHTP agreed that the extent of the information that has to be exchanged would depend on the particular scenario, including (i) whether the jurisdiction is assessed as

³ The details to be reported by relevant entities are set out in paragraph 41 of the FHTP standard, and are: the type of mobile activity being conducted; the relevant core income generating activities the entity has conducted; the amount and type of gross income (e.g. rents, royalties, dividends, sales, services); the amount and type of expenses incurred, and assets and premises held, in the course of carrying out the business; and the number of full-time, qualified employees.

having a “fully equipped monitoring mechanism” or has the standard monitoring mechanism and (ii) whether it is a case of non-compliance, high risk IP or other cases.

6. As such, depending on the exchange scenario, information to be exchanged follows the content of the applicable template contained in Annex B-E, which are the basis of the XML Schema, set out in Part 2. The corresponding template for each scenario is as follows:

Scenario	Template
1. Jurisdiction with fully equipped monitoring mechanism – cases of non-compliance	Template in Annex B
2. Jurisdiction with standard monitoring mechanism – cases of non-compliance	Template in Annex B
3. Jurisdiction with standard monitoring mechanism – high risk IP	Template in Annex C
4. Jurisdiction with fully equipped monitoring mechanism – high risk IP ⁴	Template in Annex D
5. Jurisdiction with standard monitoring mechanism – all other cases	Template in Annex E

7. The exchanges in scenario 4 and 5 are designed as a two-step procedure, in a similar way to the exchange of information technique used under the Transparency Framework for the exchange of information on rulings under BEPS Action 5. This procedure is designed to provide sufficient information to the recipient jurisdiction, while also limiting the administrative burden for jurisdictions to send and receive substantial volumes of information.

8. In a first step the no or only nominal tax jurisdiction exchanges information that is sufficient to allow the recipient jurisdiction to identify the relevant entity(ies), and for the latter to request in a second step additional information if this is considered necessary. The second step is governed by the ordinary rules and processes under the exchange of information on request, including foreseeable relevance. The same applies for any follow-up requests that may be made in response to information sent in the exchange scenarios 1-3.

9. In line with the approach used for other forms of exchange of information on request, jurisdictions should respond to subsequent requests for information as soon as possible and the information should be provided (or a status update provided) within 90 days.

10. The exchange itself should take place in the agreed XML Schema, and use the Common Transmission System, unless a different format and method for data transmission is agreed bilaterally. Any second-step exchanges under the above-mentioned two-step process, as well as any follow up requests will not take place through the XML Schema.

11. The XML User Guide instruction also includes guidance on practical issues such as the language for the exchange, and guidance on items to be included in the free text summary section where relevant.

⁴ EU Member States wishing to receive additional information items agreed at an EU level can specify these here by including the following language: “full details with respect to all high-risk IP cases in all jurisdictions (regardless of a fully-equipped monitoring mechanism), as set out in the template in Annex C”.

2. Applicable timelines

12. The applicable timeline to exchange relevant information depends on the relevant exchange scenario, as follows.

Scenario	Exchange procedure	Timeline ⁵
1. All jurisdictions – cases of non-compliance	Information to be exchanged in batches at six monthly intervals	If the non-compliance is identified in the first semester of the year, exchange by 31 December of that year; If the non-compliance is identified in the second semester of the year, exchange by 30 June of the following year. ⁶
2. Jurisdiction with fully equipped monitoring mechanism – high risk IP	Information has to be exchanged only once on an annual basis in a two-step procedure	As soon as possible and no later than 15 months after the end of the period to which the information relates.
3. Jurisdiction with standard monitoring mechanism – high risk IP	Information has to be exchanged only once on an annual basis	As soon as possible and no later than 15 months after the end of the period to which the information relates.
4. Jurisdiction with standard monitoring mechanism – all other cases	Information has to be exchanged only once on an annual basis in a two-step procedure	As soon as possible and no later than 15 months after the end of the period to which the information relates.

13. An entity may be subject of exchange of information in more than one category, but at different times. While there is no need to exchange information on entities under the category of “other cases” when information on an entity is already exchanged for high risk cases, there might be instances where “other cases” or “high risk cases” are also found to be cases of non-compliance. In such situations, both exchanges will need to occur albeit at different times, with the exchange using the “other case” template or the “high risk” template occurring first. However, if a jurisdiction is able to verify non-compliance before the time for the exchange that would otherwise occur by virtue of the entity being high risk or “other cases”, then only the exchange on non-compliance is required.

14. Finally, it is noted that the Standard notes that the design of the exchange of information mechanism will be reviewed in 2022 in conjunction with Working Party 10, to ensure it is operating effectively.⁷ This could include matters relating to the timelines

⁵ The timelines for the exchanges with respect to 2019 may need to be adjusted in order to take into account the time needed to put the international exchange framework into effect.

⁶ To give effect to this timeline, the non-compliance should be identified as soon as possible. The processes and timelines for identifying non-compliance will be reviewed by the FHTP as an important part of its ongoing review of the no or only nominal tax jurisdictions.

⁷ See paragraph 51 of the Standard.

above, as well as any other matter. The Standard also notes that particular issues can also be addressed earlier if they arise.

3. Legal mechanism to operationalise the exchange process

15. The exchange of information collected by no or only nominal tax jurisdictions pursuant to the Standard will take place as SEOI. As set out in the Standard, potential recipient jurisdictions that can receive information are tax residence jurisdictions of the immediate parent, the ultimate parent and/or the ultimate beneficial owner of a relevant entity. This is provided that the receiving jurisdiction sets out in a notification (as described in the following paragraphs) the foreseeable relevance of the information, in line with the relevant provisions of the Convention, Tax Information Exchange Agreements and bilateral tax treaties that include SEOI.⁸

16. In order to receive relevant information, potential recipient jurisdictions have to opt-in to the exchange process in respect of each no or only nominal tax jurisdiction. The opt-in process is by way of notification required to be submitted to the Co-ordinating Body Secretariat of the Convention (or for exchanges pursuant to bilateral tax agreements, to the respective no or only nominal tax jurisdiction). The template for this notification is included in Annex F of this document.⁹

17. The precondition to opt-in to receive the information from a no or only nominal tax jurisdiction is that the potential recipient jurisdiction notifies, on the basis of its applicable legislation and/or taxation principles, that the information relating to compliance with the substantial activity requirements is foreseeably relevant as it can affect the domestic tax treatment of an entity or person in its jurisdiction which is (1) the immediate parent, (2) the ultimate parent and/or (3) the ultimate beneficial owner. For example, such information may be relevant for the application of domestic CFC rules, for the application of specific defensive measures that depend on substantial activities requirements or the meeting of international standards, or for the application of certain tax reliefs to the extent there are substantial activities.

18. This is a general opt-in based on the potential for tax consequences for such an entity type, rather than a specific opt-in in respect of a specific taxpayer. The relevance has to be demonstrated separately for each scenario under the Standard and for each recipient jurisdiction in which an entity or person is resident (i.e. immediate parent, ultimate parent and ultimate beneficial owner).

19. The potential recipient jurisdiction must also notify whether it meets the confidentiality and data safeguards requirements as assessed in connection with the Global Forum process for the Automatic Exchange of Financial Account Information (AEOI Standard) and also used for the Action 5 minimum standard on exchange of information on

⁸ If a sending jurisdiction has doubts as to the foreseeable relevance of the information in the hands of a receiving jurisdiction, it should without delay open bilateral competent authority discussion to that effect.

⁹ The opt-in template is designed in a manner to also permit the opt-in for the exchange of additional information required by EU Member States.

rulings and the Action 13 minimum standard on exchange of Country-by-Country reporting.

20. Furthermore, the notification allows the receiving jurisdiction to confirm that such information is to be exchanged in the agreed XML schema and through the OECD Common Transmission System (or otherwise specify the different format and method for data transmission that has been agreed bilaterally) and the time as from which the jurisdiction is ready to start receiving information under the Standard.

21. No or only nominal tax jurisdictions are only required to exchange information with recipient jurisdictions that have notified the relevant no or only nominal tax jurisdiction no earlier than the time that is the first month beginning at least three months in advance of the next exchange date as set out above, unless the recipient jurisdiction's notification specifies a later date. For example, if a potential recipient jurisdiction submits its notification on or before 31 August 2020 and the notification specifies that the recipient jurisdiction is ready to start receiving information immediately, the no or only nominal tax jurisdictions are required to begin exchanging information with the recipient jurisdiction in December 2020 and onwards. While this timeline sets out when no or only nominal tax jurisdictions would first be expected to spontaneously exchange information, it does not prevent them from spontaneously exchanging the information earlier, if this is permitted under their law and a relevant international legal instrument is in place¹⁰.

22. Once completed notifications are provided, the no or only nominal tax jurisdiction is expected to send the information according to the notification and the Convention, Tax Information Exchange Agreements or bilateral tax treaties as applicable, based on the timelines set forth above. If circumstances change, an updated notification can be provided to commence or cease receiving certain information, and the same processes for updated notifications applies as for first notifications.

23. Given that most exchanges are anticipated to take place under the Convention, it is proposed that the opt-in process takes place by way of notification submitted to the Co-ordinating Body Secretariat pursuant to the Convention. The Co-ordinating Body Secretariat then in turn informs the competent authorities of the concerned no or only nominal tax jurisdictions of the content of the notifications. The Co-ordinating Body Secretariat will maintain a list on the secure website of no or nominal tax jurisdictions as well as the jurisdictions that have provided the required notifications with respect to each concerned no or nominal tax jurisdictions. In cases where the exchanges will rely on Tax Information Exchange Agreements or bilateral tax treaties, it is proposed that a similar notification is sent by the recipient jurisdiction to the concerned no or only nominal tax jurisdiction.

¹⁰ Even with the legal basis already in place for spontaneous exchange, the sending jurisdiction should be sensitive to the capacity of the potential recipient jurisdiction to receive and process the information.

4. Key definitions

24. The following definitions are used for the exchange framework under the Standard, drawing wherever possible on existing international tax standards:

Jurisdiction of residence of an ultimate parent, immediate parent, or ultimate beneficial owner means any jurisdiction where, under the laws of that jurisdiction, a person is liable to tax therein by reason of their domicile, residence, place of management, incorporation or citizenship, or any other criterion of a similar nature.¹¹

Reportable entity means the entity in the no or only nominal tax jurisdiction that is the object of the reporting and exchange requirements pursuant to the Standard.

Immediate parent has the meaning consistent with definitions in accounting or legal concepts in domestic law, excluding an immediate parent that has an immaterial shareholding in the reportable entity. In the absence of such domestic concepts, the immediate parent is the entity(ies) that owns directly 25% or more of the ownership or voting interests in the reportable entity. It is acknowledged that the immediate parent may be a corporate or a non-corporate entity, for example a partnership.

Ultimate parent means an entity that meets the following criteria:

- (i) it owns directly or indirectly a sufficient interest in the reportable entity such that it is required to prepare consolidated financial statements under accounting principles generally applied in its jurisdiction of residence, or would be so required if its equity interests were traded on a public securities exchange in its jurisdiction of residence; and
- (ii) there is no other entity that owns directly or indirectly an interest described in subsection (i) above in the first mentioned entity.

25. It is acknowledged that the ultimate parent may be a corporate or a non-corporate entity, for example a partnership.

Ultimate beneficial owner means the natural person(s) who ultimately owns or controls the reportable entity, including those persons who exercise ultimate effective control over a reportable entity that is a legal person or arrangement. References to “ultimately owns or controls” and “ultimate effective control” refer to situations in which ownership/control is exercised through a chain of ownership or by means of control other than direct control.

Gross income means all income from whatever source derived, including revenues from sales of inventory and properties, services, royalties, interest, premiums, dividends and any other amounts.

¹¹ This draws on the definition of resident in Article 4 of the OECD (2017), Model Tax Convention on Income and on Capital: Condensed Version 2017, OECD Publishing. www.dx.doi.org/10.1787/mtc_cond-2017-en

26. For the purposes of identifying the jurisdiction of residence, the jurisdiction may rely on reporting by the reportable entity (provided that there are penalties that apply for false reporting). In the absence of such reporting, the jurisdiction may, for legal entities, rely on the place of incorporation / formation of the entity, or, in absence thereof and for natural persons, on the address of the person or entity.

27. For the purposes of identifying the immediate parent, the ultimate parent and the ultimate beneficial owner of a reportable entity, the jurisdiction may rely on the domestic procedures it has in place in order to implement the relevant FATF Recommendations, the latest terms of reference of the Global Forum Peer Review process with respect to the standard on the exchange of information on request, the exchanges of Country-by-Country Reports pursuant to BEPS Action 13 Report, or any other domestic procedures that enable the jurisdiction to identify the immediate parent, ultimate parent, and the ultimate beneficial owner of a reportable entity.

**Substantial Activities in No or Only
Nominal Tax Jurisdictions: Additional
Guidance for the Spontaneous Exchange
of Information and Opt-in Notification
Template**

Part 2 NTJ XML Schema

User Guide Version 1.0

**July 2019
(Schema Version 1.0)**

1. How the NTJ User Guide links to the NTJ Schema

The Schema for exchanges by No or only nominal Tax Jurisdictions (NTJ) User Guide is divided into logical sections based on the schema and provides information on specific data elements and any attributes that describe each data element.

The main sections of the NTJ Schema User Guide are:

- I. The Message Header with the sender, recipient, message type and reporting period
- II. The Organisation Party type, used for identifying entities
- III. The Person Party type, used for identifying individuals
- IV. The NTJ Body, which contains two sub-sections –
 - a. Reportable Entity, containing the required information in relation to the entity in the no or only nominal tax jurisdiction that is the object of the reporting and exchange requirements pursuant to the Standard
 - b. NTJ Person, containing information on –
 - i. Exchange Nexus, which identifies the entity or person in the recipient jurisdiction that gives rise to the exchange under the Standard
 - ii. Related Person, which allows identifying the Immediate Parent in case information is sent to the jurisdiction of the Ultimate Parent, as well as the Ultimate Parent and the Immediate Parent, in case information is sent to the jurisdiction of the Ultimate Beneficial Owner.

The NTJ XML Schema is designed to be used for the exchange of information by Competent Authorities of no or only nominal tax jurisdictions with the Competent Authorities of jurisdictions interested and legally able to receive information pursuant to the Standard (i.e. those that have opted in to receive information pursuant to the Standard and that have an exchange instrument providing for the spontaneous exchange of information in force with the sending jurisdiction).

Where appropriate, no or only nominal tax jurisdictions could also consider using the schema domestically for the purpose of gathering the required information from their respective reporting entities.

For the purposes of exchanges with EU Member States under the parallel work on criterion 2.2 under the EU list of non-cooperative jurisdictions for tax purposes, exchanges with respect to high-risk IP cases by jurisdictions with a fully-equipped monitoring mechanism would occur as a one step process and rely on the template in Annex D rather than the

template in Annex E. These additional exchanges, beyond the scope of the FHTP Standard, are facilitated by the NTJ XML Schema and are highlighted *in italic* throughout the User Guide.

The requirement field for each data element and its attribute indicate whether the element is validation or optional in the schema. Every element is one or the other in the schema.

“Validation” elements MUST be present for ALL data records in a file and an automated validation check can be undertaken. The Sender should do a technical check of the data file content using XML tools to make sure all “Validation” elements are present and if they are not, correct the file. The Receiver may also do so and, if incorrect, may reject the file.

“Optional (mandatory)” elements must be provided when available and/or required by the Standard. “Optional” elements may be provided, but are not required to be filled in.

Appendix A to the NTJ User Guide shows a diagrammatic representation of the NTJ XML Schema with all its elements.

Appendix B to the NTJ User Guide contains a Glossary of namespaces for the NTJ XML Schema.

2. NTJ Schema Information

I. Message Header

The information in the message header identifies the tax administration that is sending the NTJ message. It specifies when the message was created, what reporting period the report is for, and the nature of the report (original, supplemental, etc.).

Element	Attribute	Size	Input Type	Requirement
TransmittingCountry		2-character	iso:CountryCode_Type	Validation

This data element identifies the jurisdiction of the Competent Authority transmitting the NTJ message.

It uses the 2-character alphabetic country code and country name list¹² based on the ISO 3166-1 Alpha 2 standard.

Element	Attribute	Size	Input Type	Requirement
ReceivingCountry		2-character	iso:CountryCode_Type	Validation

This data element identifies the jurisdiction of the Competent Authority receiving the NTJ message.

It uses the 2-character alphabetic country code and country name list based on the ISO 3166-1 Alpha 2 standard.

Element	Attribute	Size	Input Type	Requirement
MessageType			ntj:MessageType_EnumType	Validation

This data element specifies the type of message being sent. The only allowable entry in this field is “NTJ”.

Element	Attribute	Size	Input Type	Requirement
Warning		1 to 4'000 characters	stf:StringMin1Max4000_Type	Optional

This data element is a free text field allowing input of specific cautionary instructions about the use of the NTJ message content.

¹² The following disclaimer refers to all uses of the ISO country code list in the NTJ Schema. For practical reasons, the list is based on the ISO 3166-1 country list. The use of this list does not imply the expression by the OECD of any opinion whatsoever concerning the legal status of the territories listed. Its content is without prejudice to the status of or sovereignty over any territory, to the delimitation of international frontiers and boundaries and to the name of any territory, city or area.

Element	Attribute	Size	Input Type	Requirement
Contact		1 to 4'000 characters	stf:StringMin1Max4000_Type	Optional

This data element is a free text field allowing input of specific contact information for the sender of the message.

Element	Attribute	Size	Input Type	Requirement
MessageRefID		1 to 170 characters	stf:StringMin1Max170_Type	Validation

This data element is a free text field capturing the sender's unique message identifier (created by the sender) that identifies the particular message being sent. The identifier allows both the sender and receiver to identify the specific message later if questions arise. The Message RefID must start with the country code of the sending jurisdiction, then the receiving country code before a unique identifier.

Element	Attribute	Size	Input Type	Requirement
MessageTypeIndic			ntj:MessageTypeIndic_EnumType	Validation

Possible values:

- NTJ401 – The message contains new information
- NTJ402 – The message contains corrections/deletions for previously sent information

Element	Attribute	Size	Input Type	Requirement
ReportingPeriod			xsd:date	Validation

This data element identifies the year to which the information in the NTJ message relates in yyyy-MM-DD format, on the basis of the calendar year in which the relevant accounting year or period for the entities ended. For example, if the information relates to periods of Reportable Entities in a no or only nominal tax jurisdiction that ended in the course of the 2018 calendar year, the field would read, "2018-12-31".

Element	Attribute	Size	Input Type	Requirement
Timestamp			xsd:dateTime	Validation

This data element identifies the date and time when the message was compiled. It is anticipated that this element will be automatically populated by the host system. The format for use is yyyy-MM-DD'T'hh:mm:ss.nnn. Fractions of seconds may be used (in such a case the milli-seconds will be provided on 3 digits, see ".nnn" in the format above). Examples: 2015-03-15T09:45:30 or 2015-03-15T09:45:30.789 (with milli-seconds).

II. OrganisationParty_Type

The organisation type defines the information to be included in the NTJ XML Schema in relation to an entity, in particular the Reportable Entity in the no or only nominal tax jurisdiction, as well as the ultimate and/or immediate parent in a recipient or other jurisdiction as part of the NTJ Person element.

It is comprised of the following four data elements:

Element	Attribute	Size	Input Type	Requirement
ResCountryCode		2-character	iso:CountryCode_Type	Validation

Element	Attribute	Size	Input Type	Requirement
TIN		1 to 200 characters		ntj:TIN_Type Validation

Element	Attribute	Size	Input Type	Requirement
IN		1 to 200 characters	ntj:OrganisationIN_Type	(Optional)Mandatory

Element	Attribute	Size	Input Type	Requirement
Name		1 to 200 characters	ntj:NameOrganisation_Type	Validation

Element	Attribute	Size	Input Type	Requirement
Address			ntj:Address_Type	Validation

ResCountryCode

Element	Attribute	Size	Input Type	Requirement
ResCountryCode		2-character	iso:CountryCode_Type	Validation

This repeatable data element describes the tax residence country code(s) of the entity and must be present in all data records.

The complete information including all residence country codes that have been identified as applicable to an entity is to be sent to every Competent Authority of a jurisdiction of tax residence.

TIN (TIN_Type)

Element	Attribute	Size	Input Type	Requirement
TIN		1 to 200 characters		ntj:TIN_Type Validation

This data element provides the tax identification number (TIN) used by the tax administration of the jurisdiction of residence of the entity. In case the entity does not have a TIN, or the TIN is not known to the sending Competent Authority, the value “NOTIN” should be entered.

Element	Attribute	Size	Input Type	Requirement
TIN	issuedBy	2-character	iso:CountryCode_Type	Optional(Mandatory)

This attribute describes the jurisdiction that issued the TIN. It should be always provided, unless NOTIN is entered in the TIN element.

Entity IN (OrganisationIN_Type)

Element	Attribute	Size	Input Type	Requirement
IN		1 to 200 characters	ntj:OrganisationIN_Type	(Optional)Mandatory

This data element can be provided (and repeated) if there are other INs available, such as a company registration number or an Entity Identification Number (EIN).

Element	Attribute	Size	Input Type	Requirement
IN	issuedBy	2-character	iso:CountryCode_Type	Optional

This attribute describes the jurisdiction that issued the IN. If the issuing jurisdiction is not known then this element may be omitted.

Element	Attribute	Size	Input Type	Requirement
IN	INType	1 to 200 character	stf:StringMin1Max200_Type	Optional

This attribute defines the type of identification number being sent (e.g. LEI, EIN).

Organisation Name

Element	Attribute	Size	Input Type	Requirement
Name		1 to 200 characters	ntj:NameOrganisation_Type	Validation

This element should contain the legal name of the entity, including the domestic designation for the legal form, as indicated in its articles of incorporation or any similar document.

Address Type

Element	Attribute	Size	Input Type	Requirement
CountryCode		2-character	iso:CountryCode_Type	Validation

This data element provides the country code associated with the entity's (or person's) address.

Element	Attribute	Size	Input Type	Requirement
AddressFree		1 to 4'000 characters	stf:StringMin1Max4000_Type	Optional

This data element allows input of address information in free text. It should only be used in exceptional circumstances when it is impossible to provide the address in the fixed format.

Element	Attribute	Size	Input Type	Requirement
AddressType	legalAddressType		ntj:OECDLegalAddressType_EnumType	Optional

OECDLegalAddressType_EnumType

This is a datatype for an attribute to an address. It serves to indicate the legal character of that address (residential, business etc.)

The possible values are:

- OECD301= residentialOrBusiness
- OECD302= residential

- OECD303= business
- OECD304= registeredOffice
- OECD305= unspecified

Element	Attribute	Size	Input Type	Requirement
Street		1 to 200 characters	stf:StringMin1Max200_Type	Optional

Element	Attribute	Size	Input Type	Requirement
BuildingIdentifier		1 to 200 characters	stf:StringMin1Max200_Type	Optional

Element	Attribute	Size	Input Type	Requirement
SuiteIdentifier		1 to 200 characters	stf:StringMin1Max200_Type	Optional

Element	Attribute	Size	Input Type	Requirement
FloorIdentifier		1 to 200 characters	stf:StringMin1Max200_Type	Optional

Element	Attribute	Size	Input Type	Requirement
DistrictName		1 to 200 characters	stf:StringMin1Max200_Type	Optional

Element	Attribute	Size	Input Type	Requirement
POB		1 to 200 characters	stf:StringMin1Max200_Type	Optional

Element	Attribute	Size	Input Type	Requirement
PostCode		1 to 200 characters	stf:StringMin1Max200_Type	Optional

Element	Attribute	Size	Input Type	Requirement
City		1 to 200 characters	stf:StringMin1Max200_Type	Validation

Element	Attribute	Size	Input Type	Requirement
CountrySubentity		1 to 200 characters	stf:StringMin1Max200_Type	Optional

The above data elements comprise the AddressFix type.

III. PersonParty_Type

The data elements in this section are used to provide identification information on individuals that are the ultimate beneficial owner of a Reportable Entity, as reflected in the UBO element within the NTJ Person element. This complex type is comprised of the following data elements:

Element	Attribute	Size	Input Type	Requirement
UboType			ntj:UboType_EnumType	Optional(Mandatory)

Element	Attribute	Size	Input Type	Requirement
ResCountryCode		2-character	iso:CountryCode_Type	Validation

Element	Attribute	Size	Input Type	Requirement
TIN		1 to 200 characters	ntj:TIN_Type	(Optional) Mandatory

Element	Attribute	Size	Input Type	Requirement
Name			ntj:NamePerson_Type	Validation

Element	Attribute	Size	Input Type	Requirement
Address			ntj:Address_Type	Validation

Element	Attribute	Size	Input Type	Requirement
Nationality			iso:CountryCode_Type	Optional

Element	Attribute	Size	Input Type	Requirement
BirthInfo				(Optional) Mandatory

UBO Type

Element	Attribute	Size	Input Type	Requirement
UboType			ntj:UboType_EnumType	Optional(Mandatory)

The repeatable UBO type element indicates the type of ultimate beneficial ownership interest the person has with respect to the Reportable Entity. Possible values are:

- NTJ901 – legal person – ownership
- NTJ902 – legal person – other means
- NTJ903 – legal person – senior managing official

- NTJ904 – legal arrangement¹³ – trust – settlor
- NTJ905 – legal arrangement – trust – trustee
- NTJ906 – legal arrangement – trust – protector
- NTJ907 – legal arrangement – trust – beneficiary
- NTJ908 – legal arrangement – trust – other
- NTJ909 – legal arrangement – other – settlor -equivalent
- NTJ910 – legal arrangement – other – trustee-equivalent
- NTJ911 – legal arrangement – other – protector -equivalent
- NTJ912 – legal arrangement – other – beneficiary-equivalent
- NTJ913 – legal arrangement – other – other-equivalent

ResCountryCode

Element	Attribute	Size	Input Type	Requirement
ResCountryCode		2-character	iso:CountryCode_Type	Validation

This repeatable data element describes the tax residence country code(s) of the individual that is an ultimate beneficial owner with respect to a Reportable Entity and must be present in all data records.

The complete information including all residence country codes that have been identified as applicable to the individual is to be sent to every Competent Authority of a jurisdiction of tax residence of the individual.

TIN Type

Element	Attribute	Size	Input Type	Requirement
TIN		1 to 200 characters	ntj:TIN_Type	Validation

This data element provides the tax identification number (TIN) used by the tax administration of the jurisdiction of tax residence of the individual. In case the individual does not have a TIN, or the TIN is not known to the sending Competent Authority, the value “NOTIN” should be entered.

Element	Attribute	Size	Input Type	Requirement
TIN	issuedBy	2-character	iso:CountryCode_Type	(Optional) Mandatory

This attribute describes the jurisdiction that issued the TIN. It should be always provided, unless NOTIN is entered in the TIN element.

¹³ It is expected that there will only be limited instances in which the Reportable Entity is a legal arrangement.

NamePerson_Type

Element	Attribute	Size	Input Type	Requirement
Name			ntj:NamePerson_Type	Validation

This data element allows to report both the name at birth and the name after marriage.

Element	Attribute	Size	Input Type	Requirement
PrecedingTitle		1 to 200 characters	stf:StringMin1Max200_Type	Optional

Element	Attribute	Size	Input Type	Requirement
Title		1 to 200 characters	stf:StringMin1Max200_Type	Optional

Element	Attribute	Size	Input Type	Requirement
FirstName		1 to 200 characters	stf:StringMin1Max200_Type	Validation

This data element is required for identifying ultimate beneficial owners in the context of the NTJ Schema. If the sending Competent Authority was not provided with a complete first name for an individual, an initial or NFN (“No First Name”) may be used here.

Element	Attribute	Size	Input Type	Requirement
FirstName	xnlNameType	1 to 200 characters	stf:StringMin1Max200_Type	Optional

Element	Attribute	Size	Input Type	Requirement
MiddleName		1 to 200 characters	stf:StringMin1Max200_Type	Optional

This data element allows the individual’s Middle Name to be entered. The data is optional.

Element	Attribute	Size	Input Type	Requirement
MiddleName	xnlNameType	1 to 200 characters	stf:StringMin1Max200_Type	Optional

Element	Attribute	Size	Input Type	Requirement
NamePrefix		1 to 200 characters	stf:StringMin1Max200_Type	Optional

Element	Attribute	Size	Input Type	Requirement
NamePrefix	xnlNameType	1 to 200 characters	stf:StringMin1Max200_Type	Optional

Element	Attribute	Size	Input Type	Requirement
LastName		1 to 200 characters	stf:StringMin1Max200_Type	Validation

This data element is required. This field can include any prefix or suffix legally used by the individual that is the ultimate beneficial owner with respect to a Reportable Entity.

As the element is a string it is possible to use this for a free format name or two last names although wherever possible the structured first name and last name should be used.

Element	Attribute	Size	Input Type	Requirement
LastName	xnlNameType	1 to 200 characters	stf:StringMin1Max200_Type	Optional

Element	Attribute	Size	Input Type	Requirement
GenerationIdentifier		1 to 200 characters	stf:StringMin1Max200_Type	Optional

Element	Attribute	Size	Input Type	Requirement
Suffix		1 to 200 characters	stf:StringMin1Max200_Type	Optional

Element	Attribute	Size	Input Type	Requirement
GeneralSuffix		1 to 200 characters	stf:StringMin1Max200_Type	Optional

Nationality

Element	Attribute	Size	Input Type	Requirement
Nationality			iso:CountryCode_Type	Optional

The nationality element is not to be provided as part of the NTJ Schema.

BirthInfo

Element	Attribute	Size	Input Type	Requirement
BirthInfo				Optional

The Birth Info element is composed of:

Element	Attribute	Size	Input Type	Requirement
BirthDate			xsd:date	Optional

This data element identifies the date of birth of the individual that is the ultimate beneficial owner with respect to a Reportable Entity. The data format is yyyy-MM-DD.

The three data elements below indicate to the place of birth of the ultimate beneficial owner.

Element	Attribute	Size	Input Type	Requirement
City		1 to 200 characters	stf:StringMin1Max200_Type	Optional

Element	Attribute	Size	Input Type	Requirement
CitySubentity		1 to 200 characters	stf:StringMin1Max200_Type	Optional

Element	Attribute	Size	Input Type	Requirement
CountryInfo				Optional

This data element gives a choice between a current jurisdiction (identified by 2-character country code) or a former jurisdiction (identified by name). One or the other should be supplied if place of birth is reported, together with City or City and CitySubentity.

Element	Attribute	Size	Input Type	Requirement
CountryCode		2-character	iso:CountryCode_Type	Validation

Element	Attribute	Size	Input Type	Requirement
FormerCountryName		1 to 200 characters	stf:StringMin1Max200_Type	Validation

IV. NTJ Body

The NTJ Body contains the information on the Reportable Entity (i.e. the identification and activity-related information on the entity subject to reporting), as well as on the Exchange Nexus (i.e. the entity or person in the receiving jurisdiction that gives rise to the exchange under the Standard in light of its link with the Reportable Entity) and Related Persons.

Element	Attribute	Size	Input Type	Requirement
NtjBody			ntj:CorrectableNtjBody_Type	Validation

As indicated above, the NTJ Body element is composed of the following elements:

Element	Attribute	Size	Input Type	Requirement
ReportableEntity			ntj:ReportableEntity_Type	Validation

This element contains the identification information and, where applicable, key accounting and (IP or non-IP) activity-related data on the entity that gives rise to the exchange of the information pursuant to the Standard by the no or only nominal tax jurisdiction.

Element	Attribute	Size	Input Type	Requirement
ExchangeNexus			ntj:NtjPerson_Type	Validation

This element contains the identification information on the entity or person that gives rise to the exchange of the information pursuant to the Standard by the no or only nominal tax jurisdiction. It follows the NTJ Person Type.

Element	Attribute	Size	Input Type	Requirement
RelatedPerson			ntj:NtjPerson_Type	Optional

The Related Person element contains the identification information on other relevant persons to be reported pursuant to the Standard, i.e. the ultimate or immediate parent and/or the ultimate beneficial owner. The reporting in this respect would be follows:

- In case the ultimate beneficial owner is giving rise to the exchange nexus, then the ultimate and immediate parents may be identified in this element.
- In case the ultimate parent is giving rise to the exchange nexus, then the immediate parent(s) may be identified in this element.
- In case the immediate parent is giving rise to the exchange nexus, then this element is not to be provided.

This element can be repeated as required.

Element	Attribute	Size	Input Type	Requirement
DocSpec			stf:DocSpec_Type	Validation

The DocSpec identifies the particular record within the NTJ message being transmitted. It permits the identification of record requiring correction. For further guidance see the Corrections section in this User Guide.

IV.a. Reportable Entity

Element	Attribute	Size	Input Type	Requirement
ReportableEntity			ntj:ReportableEntity_Type	Validation

The Reportable element is composed of:

Element	Attribute	Size	Input Type	Requirement
Entity			ntj:OrganisationParty_Type	Validation

The Entity element includes the identification information with respect to the Reportable Entity in the no or only nominal tax jurisdiction. The element follows the Organisation Party Type set out above.

Element	Attribute	Size	Input Type	Requirement
NameGroup		1 to 200 characters	stf:StringMin1Max200_Type	Optional

The Name Group element allows the specification of the commercial or commonly-used name of the group to which the Reportable Entity belongs. The element is optional.

Element	Attribute	Size	Input Type	Requirement
ReportingReason			ntj:ReportingReason_EnumType	Validation

The Reporting Reason element indicates the reason for preparing the report on the Reportable Entity pursuant to the FHTP Standard. The possible values are:

- NTJ801 – Fully equipped – Non-Compliant Entity
- NTJ802 – Standard – Non-Compliant Entity
- NTJ803 – Standard – High-risk IP
- NTJ804 – Fully equipped – High-risk IP
- NTJ805 – Standard – Other Entities
- *NTJ806 – High-risk IP – exchanges with EU Member States*
- NTJ807 – Reportable Entity tax resident in another jurisdiction

Element	Attribute	Size	Input Type	Requirement
Period				Validation

The Period element indicates the accounting year or period to which the information reported with respect to the Reportable Entity relates.

Element	Attribute	Size	Input Type	Requirement
Activities			Activities_Type	Optional(Mandatory)

The Activities elements sets out the relevant key accounting data, as well as the gross income, expenses and employees for each of the activities of the Reportable Entity. It is to be provided in all instances, except for exchanges that are solely due to a Reportable Entity being tax resident in another jurisdiction, with NTJ807 having been selected as Reporting Reason.

With respect to the exchange scenarios contemplated by the Standard this information should relate to the following:

- Non-compliant entities: for activities in respect of which the substance requirements have not been met, the gross income, expenses and number of employees is to be provided
- High-risk IP activities (fully-equipped monitoring mechanism, *except exchanges with EU Member States*): for the relevant high-risk IP activities the gross income is to be provided
- High-risk IP activities (standard monitoring mechanism *and all exchanges with EU Member States*): for the relevant high-risk IP activities the gross income, expenses and number of employees is to be provided
- Activities of compliant, non high-risk IP entities (standard monitoring mechanism): for each relevant activity the gross income is to be provided

In all instances the total gross annual income of the entity is to be provided.

In addition, in all instances, except for compliant, non high-risk IP entities in jurisdictions with a standard monitoring mechanism and high-risk scenarios with a fully-equipped monitoring mechanism *exchanged with non-EU Member States*, the net book value of the tangible assets held in the course of carrying out the business is to be provided.

Element	Attribute	Size	Input Type	Requirement
Summary			stf:StringMin1Max4000WithLang_Type	Optional(Mandatory)

The Summary element allows the provision of narrative information as required by the Standard.

In case of non-compliant entities, the elements for which the entity has failed the core income generating activities test should be set out, as well as any other relevant information.

For entities with high-risk IP activities in jurisdictions with a standard monitoring mechanism *and for any exchanges on high-risk IP activities with EU Member States*, this element should contain a summary of the core income generating activities, including whether and how the entity sought to rebut the high-risk presumption under the jurisdiction's substance legislation and whether the local authorities agreed, as well as any other relevant information, including information required to be provided by the entity under the jurisdiction's substance legislation. Relevant information to rebut the presumption would include a summary of a set of detailed information made available by the entity, such as detailed business plans, which demonstrate the commercial rationale for holding the IP assets in the jurisdiction; employee information, including level of experience, type of contracts, qualifications, and duration of employment; and evidence that decision making is taking place within the jurisdiction, rather than periodic decisions of non-resident board members.¹⁴

In other instances, this element should not be provided.

¹⁴ In cases where there is a need for original documents to be transmitted for the purposes of rebutting the presumption, it is acknowledged that such documents would be sent through traditional SEOI means, outside of the XML schema.

The element is repeatable.

Element	Attribute	Size	Input Type	Requirement
Summary	language		iso:LanguageCode_Type	Optional

In this attribute to the Summary element, the language in which the information is entered can be specified.

Reportable Entity, Period

Element	Attribute	Size	Input Type	Requirement
Period				Validation

The Period element indicates the accounting year or period to which the information reported with respect to the Reportable Entity relates. It is composed of:

Element	Attribute	Size	Input Type	Requirement
StartDate			xsd:date	Validation

The Start Date element indicates the date on which the relevant account year or period of the Reportable Entity started. It should be entered in yyyy-MM-DD format. For example, 1 January 2019 would read, “2019-01-01”.

Element	Attribute	Size	Input Type	Requirement
EndDate			xsd:date	Validation

The End Date element indicates the date on which the relevant account year or period of the Reportable Entity ended. It should be entered in yyyy-MM-DD format. For example, 31 December 2019 would read, “2019-12-31”.

Reportable Entity, Activities

Element	Attribute	Size	Input Type	Requirement
Activities			ntj:Activities_Type	Validation

The Activities elements sets out the relevant key accounting data, as well as the gross income, expenses and employees for each of the activities of the Reportable Entity. It is composed of:

Element	Attribute	Size	Input Type	Requirement
KeyData				Validation

The Key Data element contains the key (IP or non-IP) activity-related information of the Reportable Entity, including the gross income, expenses and number of employees per activity, as required by the Standard. Details of the element and its sub-elements are set out further below.

Element	Attribute	Size	Input Type	Requirement
AnnualIncome			ntj:MonAmnt_Type	Validation

The Annual Income element should contain the total annual gross income of the Reportable Entity. It is to be provided in all instances.

Element	Attribute	Size	Input Type	Requirement
AnnualIncome	currCode	3 characters	iso:currCode_Type	Validation

This element specifies the currency of the Annual Income element. All amounts must be accompanied by the appropriate 3 character currency code based on the ISO 4217 Alpha 3 Standard.

Element	Attribute	Size	Input Type	Requirement
NetBookValue			ntj:MonAmnt_Type	Optional(Mandatory)

The Net Book Value element should contain the net book value of the tangible assets held in the course of carrying out the business of the Reportable Entity. It should be provided in all instances, except for compliant, non high-risk IP entities in jurisdictions with a standard monitoring mechanism and high-risk scenarios with a fully-equipped monitoring mechanism *exchanged with non-EU Member States*.

Element	Attribute	Size	Input Type	Requirement
NetBookValue	currCode	3 characters	iso:currCode_Type	Validation

This element specifies the currency of the Annual Income element. All amounts must be accompanied by the appropriate 3 character currency code based on the ISO 4217 Alpha 3 Standard.

Reportable Entity, Activities, Key data

Element	Attribute	Size	Input Type	Requirement
KeyData				Validation

The Key Data element contains the key (IP or non-IP) activity-related information of the Reportable Entity, including the gross income, expenses and number of employees per activity, as required by the Standard.

Depending on whether reporting is required in relation to high-risk IP scenarios or with respect to other scenarios, i.e. non-IP scenarios and with respect to (IP or non-IP) non-compliant entities, either the IP or Other element should be chosen.

Element	Attribute	Size	Input Type	Requirement
IP			ntj:ActivitiesKeyDataIP_Type	Validation

The IP element allows entering the activities and the key indicators for Reportable Entities that are to be reported with respect to their high-risk IP activities.

Element	Attribute	Size	Input Type	Requirement
Other			ntj:ActivitiesKeyDataOther_Type	Validation

The Other element allows entering the activities and the key indicators for Reportable Entities that are to be reported with respect to their non-IP activities or because they are (IP or non-IP) non-compliant entities.

Reportable Entity, Activities, Key data, IP

Element	Attribute	Size	Input Type	Requirement
TypeIncome			ntj:ActivitiesKeyDataIP_EnumType	Validation

The repeatable Type Income element specifies the types of high-risk IP activities that a Reportable Entity was active in during the relevant year. The possible values are:

- NTJ601 - Royalties
- NTJ602 – Gains from sale of IP asset
- NTJ603 – Other

For each of the selected values the below information on the gross income, expenses and number of employees in relation to the selected activity can be entered, as required by the Standard.

Element	Attribute	Size	Input Type	Requirement
GrossIncome			ntj:MonAmnt_Type	Validation

The Gross Income element contains the gross income realised during the relevant year by the Reportable Entity in relation to the selected activity. It is to be provided in all instances.

Element	Attribute	Size	Input Type	Requirement
GrossIncome	currCode	3 characters	iso:currCode_Type	Validation

This element specifies the currency of the Gross Income element. All amounts must be accompanied by the appropriate 3 character currency code based on the ISO 4217 Alpha 3 Standard.

Element	Attribute	Size	Input Type	Requirement
Expenses			ntj:Expenses_Type	Optional(Mandatory)

The Expenses element contains the operating expenses incurred by the Reportable Entity in relation to the selected activity over the relevant accounting year or period. With respect to the high-risk IP activities, this information is to be provided only when the jurisdiction of the Reportable Entity has a standard monitoring mechanism *or when the exchange is with an EU Member State*. It follows the Expenses Type set out below.

Element	Attribute	Size	Input Type	Requirement
Employees			xsd:integer	Optional(Mandatory)

The Employees element contains the number of full-time equivalent, qualified employees that have been employed in the relevant year with respect to the selected activity. With respect to the high-risk IP activities, this information is to be provided only when the jurisdiction of the Reportable Entity has a standard monitoring mechanism *or when the exchange is with an EU Member State*.

Reportable Entity, Activities, Key data, Other

Element	Attribute	Size	Input Type	Requirement
TypeIncome			ntj:ActivitiesKeyDataOther_EnumType	Validation

The repeatable Type Income element specifies the types of the activities that a Reportable Entity was active in during the relevant year and for which the substance requirements have not been met. The possible values are:

- NTJ501 – Headquarters
- NTJ502 – Financing and Leasing
- NTJ503 – Banking
- NTJ504 – Insurance
- NTJ505 – Distribution and service centre
- NTJ506 – Shipping
- NTJ507 – Holding
- NTJ508 – Fund management
- NTJ509 – Intellectual property
- NTJ510 – Other

For each of the selected values the below information on the gross income, expenses and number of employees in relation to the selected activity can be entered, as required by the Standard. When the value NTJ510 – Other is selected, additional narrative information on the type of income should be provided in the Summary element.

Element	Attribute	Size	Input Type	Requirement
GrossIncome			ntj:MonAmnt_Type	Validation

The Gross Income element contains the gross income realised during the relevant year by the Reportable Entity in relation to the selected activity. It is to be provided in all instances.

Element	Attribute	Size	Input Type	Requirement
GrossIncome	currCode	3 characters	iso:currCode_Type	Validation

This element specifies the currency of the Gross Income element. All amounts must be accompanied by the appropriate 3 character currency code based on the ISO 4217 Alpha 3 Standard.

Element	Attribute	Size	Input Type	Requirement
Expenses			ntj:Expenses_Type	Optional(Mandatory)

The Expenses element contains the operating expenses incurred by the Reportable Entity in relation to the selected activity over the relevant accounting year or period. This information is to be provided only for non-compliant entities and for high-risk IP entities in jurisdictions with a standard monitoring mechanism *or when the exchange is with an EU Member State*. It follows the Expenses Type set out below.

Element	Attribute	Size	Input Type	Requirement
Employees			xsd:integer	Optional(Mandatory)

The Employees element contains the number of full-time equivalent, qualified employees that have been employed in the relevant year with respect to the selected activity. This information is to be provided only for non-compliant entities and for high-risk IP entities in jurisdictions with a standard monitoring mechanism *or when the exchange is with an EU Member State*.

Reportable Entity, Activities, Key data, Expenses

Element	Attribute	Size	Input Type	Requirement
Expenses			ntj:Expenses_Type	Optional(Mandatory)

The Expenses element contains the operating expenses incurred by the Reportable Entity in relation to the selected activity over the relevant accounting year or period. It is composed of the Direct and Outsourcing elements.

Element	Attribute	Size	Input Type	Requirement
Direct			ntj:MonAmnt_Type	Validation

The Direct element specifies the expenses directly incurred by the Reportable Entity with respect to the selected activity.

Element	Attribute	Size	Input Type	Requirement
Direct	currCode	3 characters	iso:currCode_Type	Validation

This element specifies the currency of the Direct element. All amounts must be accompanied by the appropriate 3 character currency code based on the ISO 4217 Alpha 3 Standard.

Element	Attribute	Size	Input Type	Requirement
Outsourcing			ntj:MonAmnt_Type	Validation

The Outsourcing element specifies the outsourcing expenditure incurred by the Reportable Entity with respect to the selected activity.

Element	Attribute	Size	Input Type	Requirement
Outsourcing	currCode	3 characters	iso:currCode_Type	Validation

This element specifies the currency of the Outsourcing element. All amounts must be accompanied by the appropriate 3 character currency code based on the ISO 4217 Alpha 3 Standard.

IV.b. NTJ Person

The NTJ Person element identifies the entity or person that is being reported due to it being resident in the receiving jurisdiction (i.e. the entity or person that gives rise to the exchange with the receiving jurisdiction under the Standard, in light of its link with the Reportable Entity), as well as any Related Person. For an entity, the format follows the Organisation Party Type set out above, whereas for the ultimate beneficial owner the format is the Person Party Type set out above.

Element	Attribute	Size	Input Type	Requirement
ID				Validation

The ID element allows a choice between Entity or UBO, depending on where the reporting relates to an entity or an individual (i.e. the ultimate beneficial owner).

Element	Attribute	Size	Input Type	Requirement
Entity			ntj:OrganisationParty_Type	Validation

The Entity element contains the identification information for an entity in the receiving jurisdiction. For exchanges with respect to a Reportable Entity that is tax resident in the recipient jurisdiction, this element should reproduce the identification information of the Reportable Entity. It is provided in the Organisation Party Type format.

Element	Attribute	Size	Input Type	Requirement
UBO			ntj:PersonParty_Type	Validation

The UBO element contains the identification information for the ultimate beneficial owner. It is provided in the Person Party Type format.

Element	Attribute	Size	Input Type	Requirement
Nexus			ntj:Nexus_EnumType	Validation

In addition to the identification information provided as part of the Entity or UBO element, the Nexus element identifies the link with the Reportable Entity. The possible values are:

- NTJ701 – Ultimate parent
- NTJ702 – Immediate parent
- NTJ703 – Ultimate beneficial owner
- NTJ704 – Reportable Entity tax resident in another jurisdiction
- NTJ705 – Ultimate parent – Reportable Entity tax resident in another jurisdiction
- NTJ706 – Immediate parent – Reportable Entity tax resident in another jurisdiction
- NTJ707 – Ultimate beneficial owner – Reportable Entity tax resident in another jurisdiction

Schema version

The version of the schema and the corresponding business rules have a unique version number assigned that usually consists of two numbers separated by a period sign: major and minor version (ex: 1.0). The version number could also contain a third number (ex: 1.0.1) which indicates that the schema was revised with very small changes (ex: only new enumerations were added).

The version is identified by the version attribute on the schema element. The target namespace of the NTJ XML Schema contains only the major version.

Element	Attribute	Size	Input Type	Requirement
NTJ_OECD	version	1 to 10 characters	stf:StringMin1Max10_Type	(Optional) Mandatory

The root element NTJ_OECD version attribute in the XML report file must be set to the value of the schema version. This will identify the schema version that was used to create the report.

For the NTJ XML Schema version 1.0, the version attribute must be set to the value “1.0”.

Corrections

Introduction

In case the sending jurisdiction becomes aware of inaccurate information, be it in relation to the Reportable Entity or the NTJ Person, a correction will need to be made. As long as the error is discovered prior to the exchange of the NTJ Report for a given fiscal year, no correction, as set out in this section, would be required.

However, in case an error is discovered after the exchange of the NTJ Report, adjustments to part of the NTJ report will need to be made, in accordance with the guidance set out in this section.

In order to facilitate a targeted reporting of corrections, the NTJ XML Schema has only one correctable type called NTJ Body, thus even if only one field needs to be corrected, the whole NTJ Body will be corrected.

Technical Guidance

This section describes how to make automatic corrections by sending a file of corrected data that can be processed in the same systems as the original data that was received. Reference to corrections in this section also includes deletion of records.

In order to identify the elements to correct, the top-level element NTJ Body includes an element of the DocSpec_Type, which contains the necessary information for corrections.

DocSpec Type

Element	Attribute	Size	Input Type	Requirement
DocSpec			stf:DocSpec_Type	Validation

DocSpec identifies the particular record within the NTJ message being transmitted. It permits the identification of records requiring correction. The DocSpec element is composed of the following:

Element	Attribute	Size	Input Type	Requirement
DocTypeIndic			stf:OECDDocTypeIndic_EnumType	Validation

This element specifies the type of data being submitted.

Allowable entries are:

- OECD0 = Resent Data (not used for the NTJ schema)
- OECD1 = New Data
- OECD2 = Corrected Data
- OECD3 = Deletion of Data
- OECD10 = Resent Test Data (not used for the NTJ schema)
- OECD11 = New Test Data
- OECD12 = Corrected Test Data
- OECD13 = Deletion of Test Data

A message can either contain new records (OECD1) or corrections and/or deletions (OECD2 and OECD3), but should not contain a mixture of both.

The codes OECD10 through OECD13 must only be used during agreed testing periods or on the basis of a bilateral agreement on testing. This is to ensure that the Competent Authorities avoid test data becoming mingled with ‘live’ data.

Element	Attribute	Size	Input Type	Requirement
DocRefID		1 to 200 characters	stf:StringMin1Max200_Type	Validation

The DocRefID is a unique identifier for the document (i.e. one record and all its children data elements). An element containing a correction (or deletion) must have a new unique DocRefID for future reference.

Element	Attribute	Size	Input Type	Requirement
CorrDocRefID		1 to 200 character	stf:StringMin1Max200_Type	Optional

The CorrDocRefID references the DocRefID of the element to be corrected or deleted. It must always refer to the latest reference of the record (DocRefID) that was sent.

In this way, a series of corrections or amendments can be handled as each correction completely replaces the previous version. The NTJ Correction Examples below show how this works in practice.

Uniqueness of MessageRefID and DocRefID

In order to ensure that a message and a record can be identified and corrected, the MessageRefID and DocRefID must be unique in space and time (i.e. there must be no other message or record in existence that has the same reference identifier).

The MessageRefID identifier can contain whatever information the sender uses to allow identification of the particular message but must start with the country code of the sending jurisdiction, then the receiving country code before a unique identifier.

e.g. CALU123456789

This MessageRefID indicates that the Canada is the country of the sending Competent Authority, the receiving Competent Authority is Luxembourg and that the unique identifier is “123456789”.

The unique identifier in the DocRefID is used by the sending Competent Authority to identify a unique NTJ record and is composed of the country code of the sending jurisdiction, followed by a unique identifier.

e.g. CA286abc123xyz

This DocRefID indicates that Canada is the sending country and the unique identifier is “286abc123xyz”.

MessageSpec, Corrections and Cancellations

Correction messages must have their own unique MessageRefID so they can also be corrected in the future. There is no equivalent for the DocSpec type when it comes to messages as a whole.

To cancel a complete message, there is no element in the MessageSpec which can be used for that purpose. Instead, a correction message should be sent deleting all records of the erroneous message in these instances.

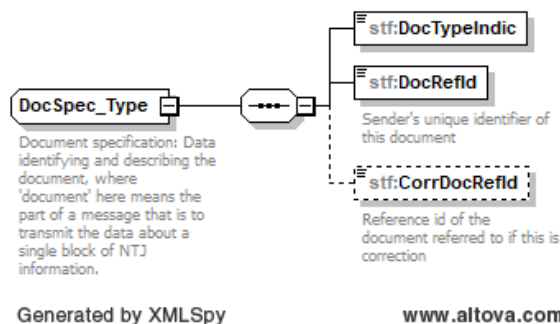

The following examples show how the DocSpec_Type elements are used to correct data previously sent.

When correcting a record, we will always correct the whole NTJ Body record (with all its sub-elements). The following correction examples will provide a few examples of this concept.

3. NTJ Correction examples

First example: a correction is made in relation to the Reportable Entity. The correction is to be made in the Activities – Annual Income field.

The correction file is sent from France (containing only corrections, not a mix of new and corrected data).

MessageRefID: FRCAFranceNationalPart00001

For all Corrections, the whole NTJ Body must be resubmitted with all sub-elements, the Reportable Entity, Exchange Nexus and all Related Person(s). The Reportable Entity will include the corrected Annual Income.

The DocRefD of the record to be corrected is FR0001.

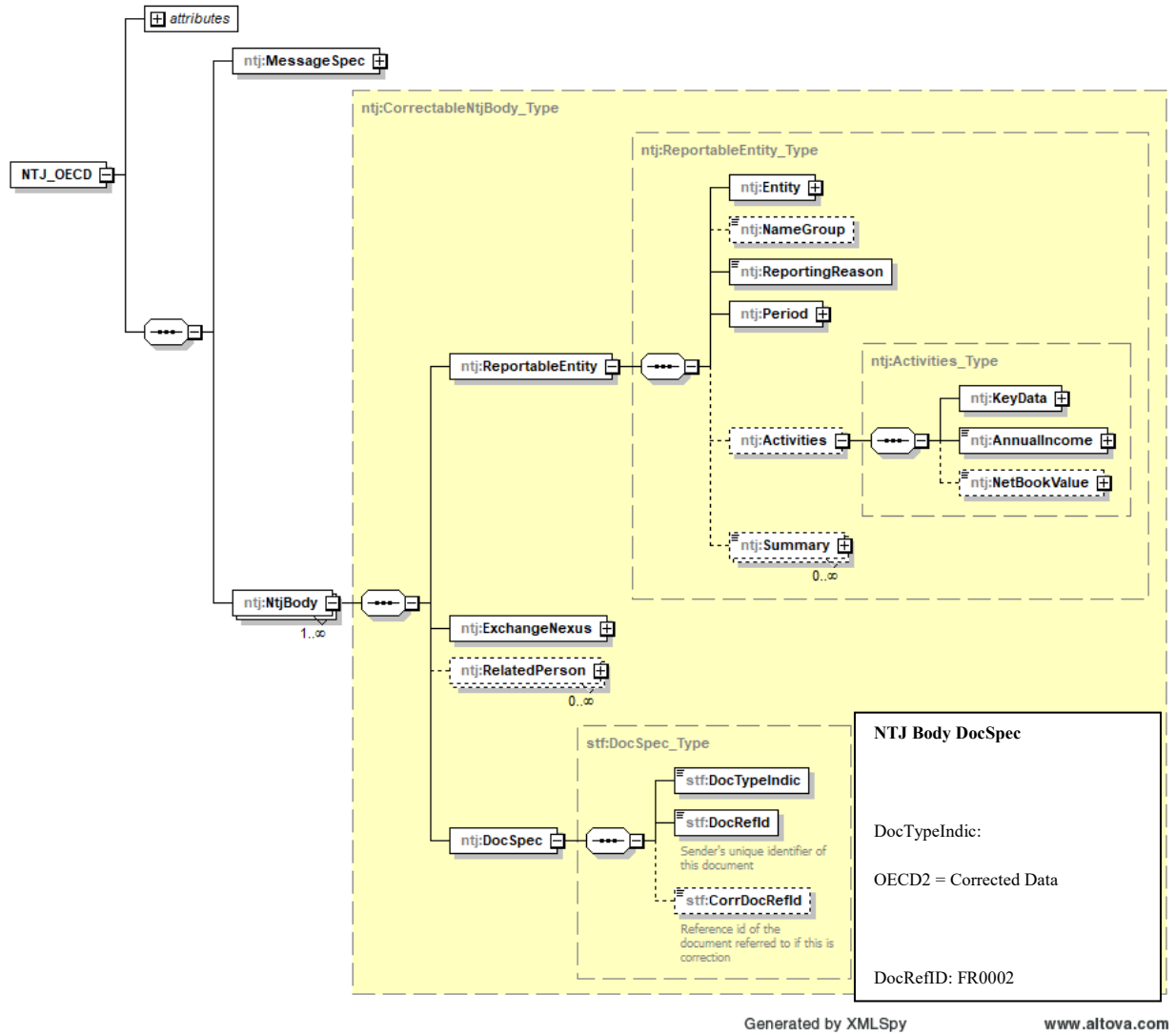

Second example: a correction is made in relation to the Exchange Nexus. The correction is to be made to the address of the ultimate beneficial owner.

The correction file is sent from France (containing only corrections, not a mix of new and corrected data).

MessageRefID: FRCAFranceNationalPart00002

For all Corrections, the whole NTJ Body must be resubmitted with all sub-elements, the Reportable Entity, Exchange Nexus and all Related Person(s). The Exchange Nexus will include the corrected address of the ultimate beneficial owner.

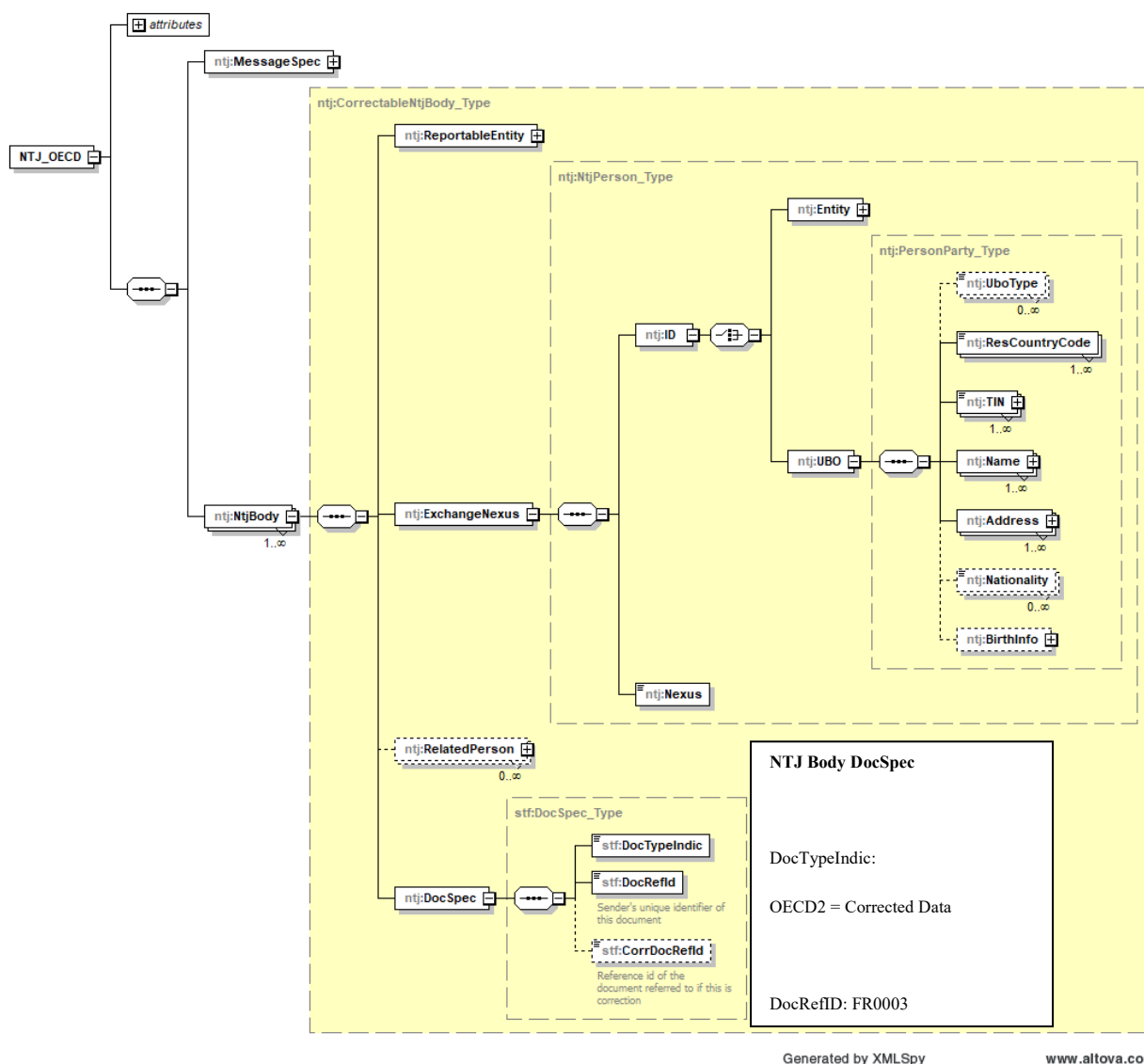

Third example: the Reportable Entity must be corrected for an existing NTJ Body. Under the Activities – Key Data, one of the IP elements must be removed.

For all Corrections, the whole NTJ Body must be resubmitted with all sub-elements, the Reportable Entity, Exchange Nexus and all Related Person(s). Under the Activities – Key Data, the IP element will be removed while all other previous IP(s) element will be resubmitted with the correction.

The correction file is sent from France (containing only corrections, not a mix of new and corrected data).

MessageRefID: FRCAFranceNationalPart00003

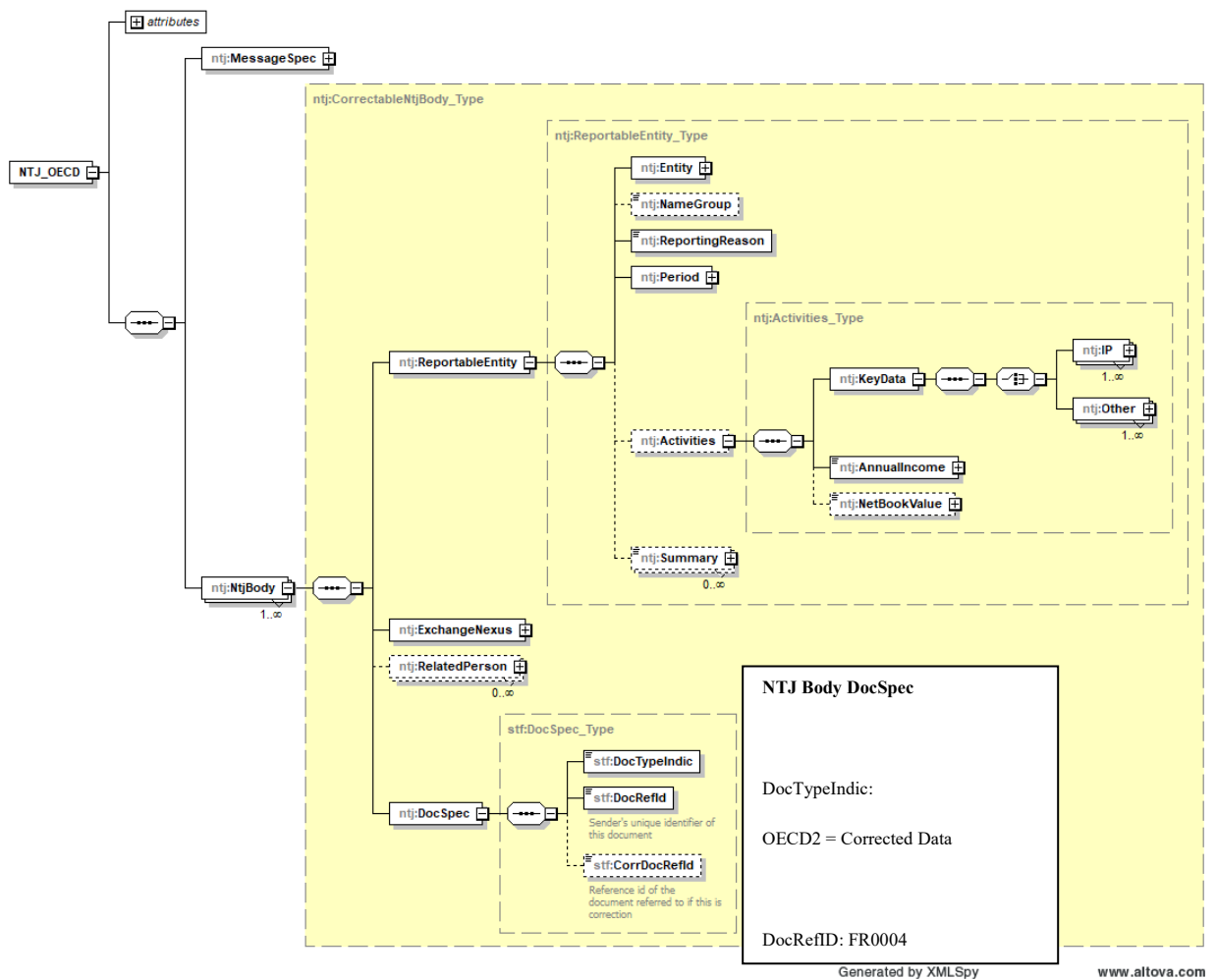

Annex A. NTJ XML Schema v. 1.0 Diagrams

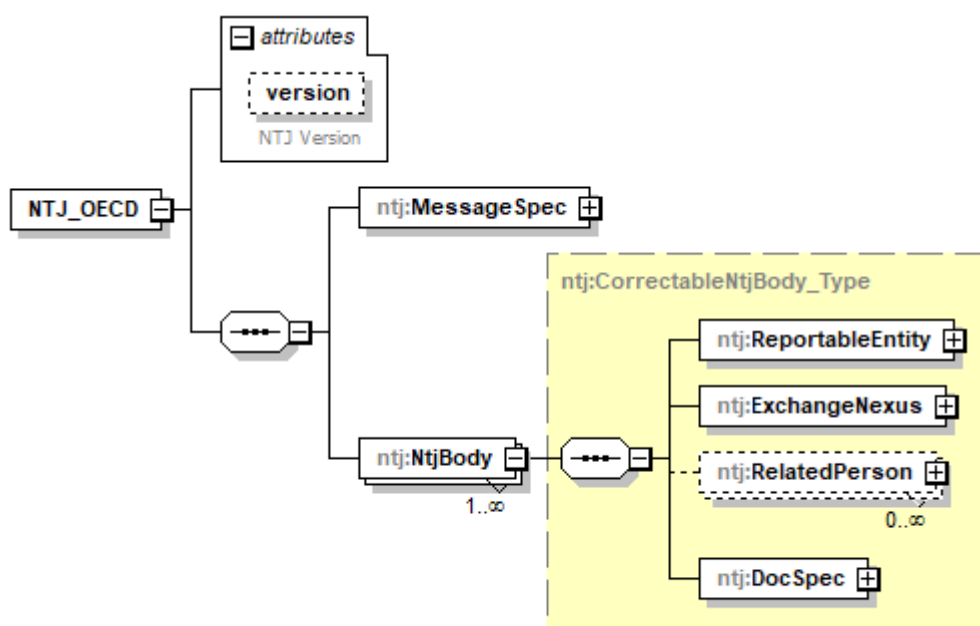

Generated by XMLSpy

www.altova.com

Message Header

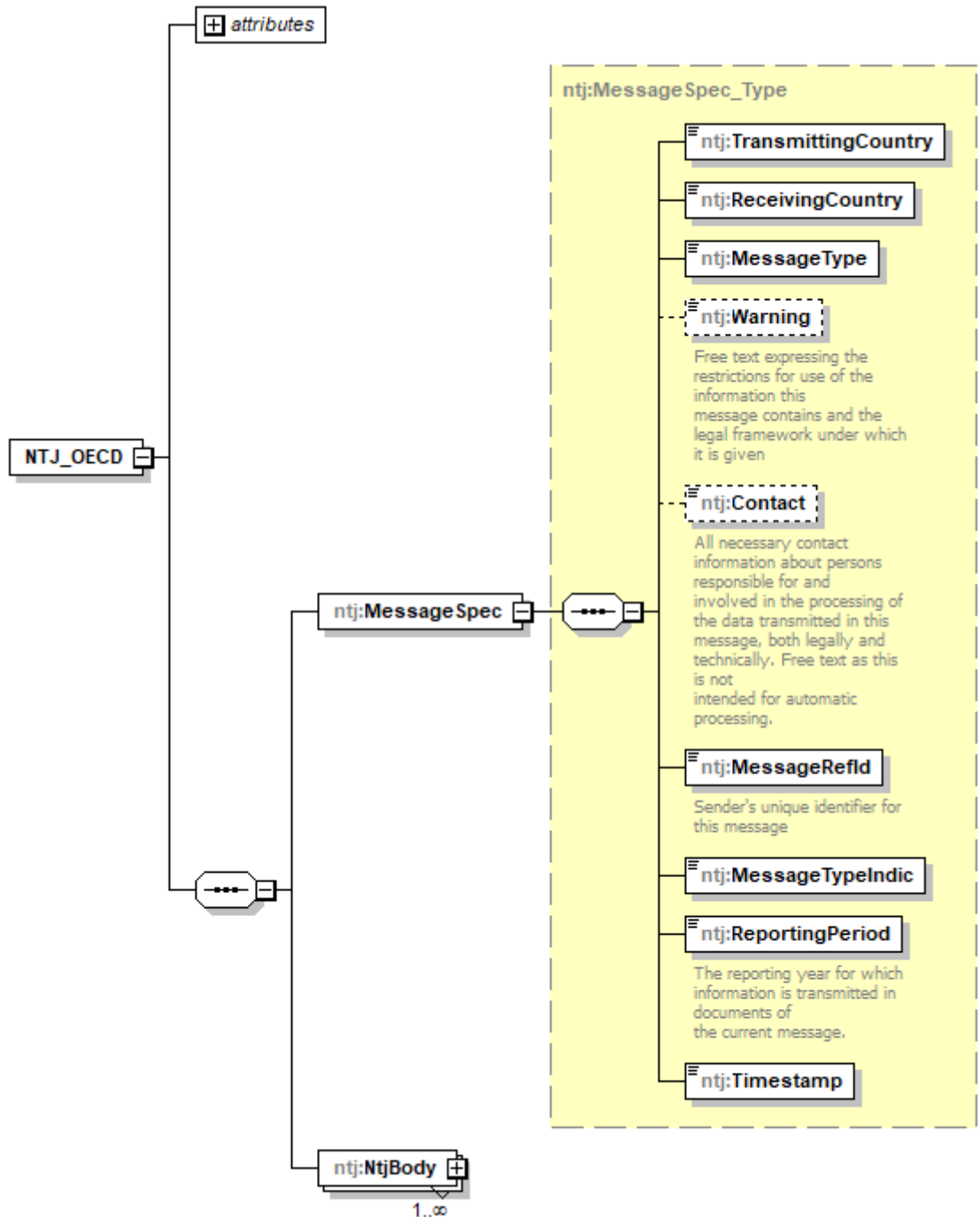

Generated by XMLSpy

www.altova.com

NTJ Body

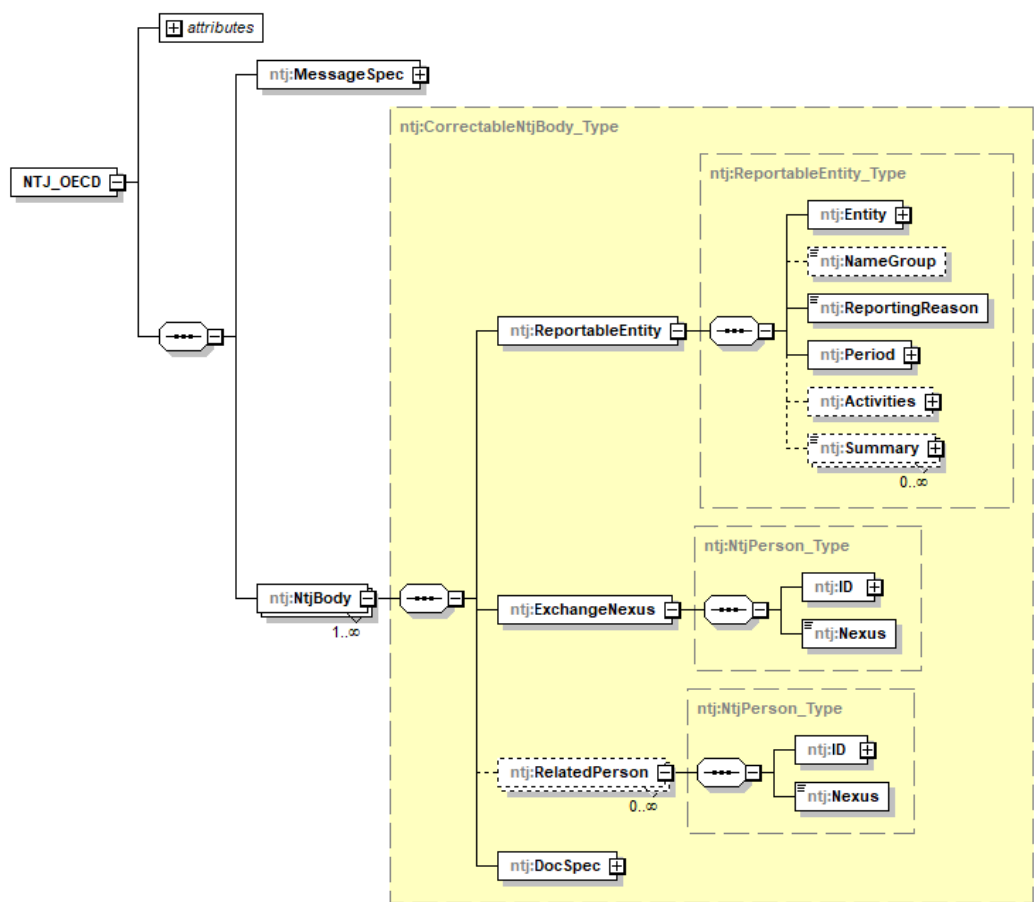

Generated by XMLSpy

www.altova.com

Reportable Entity

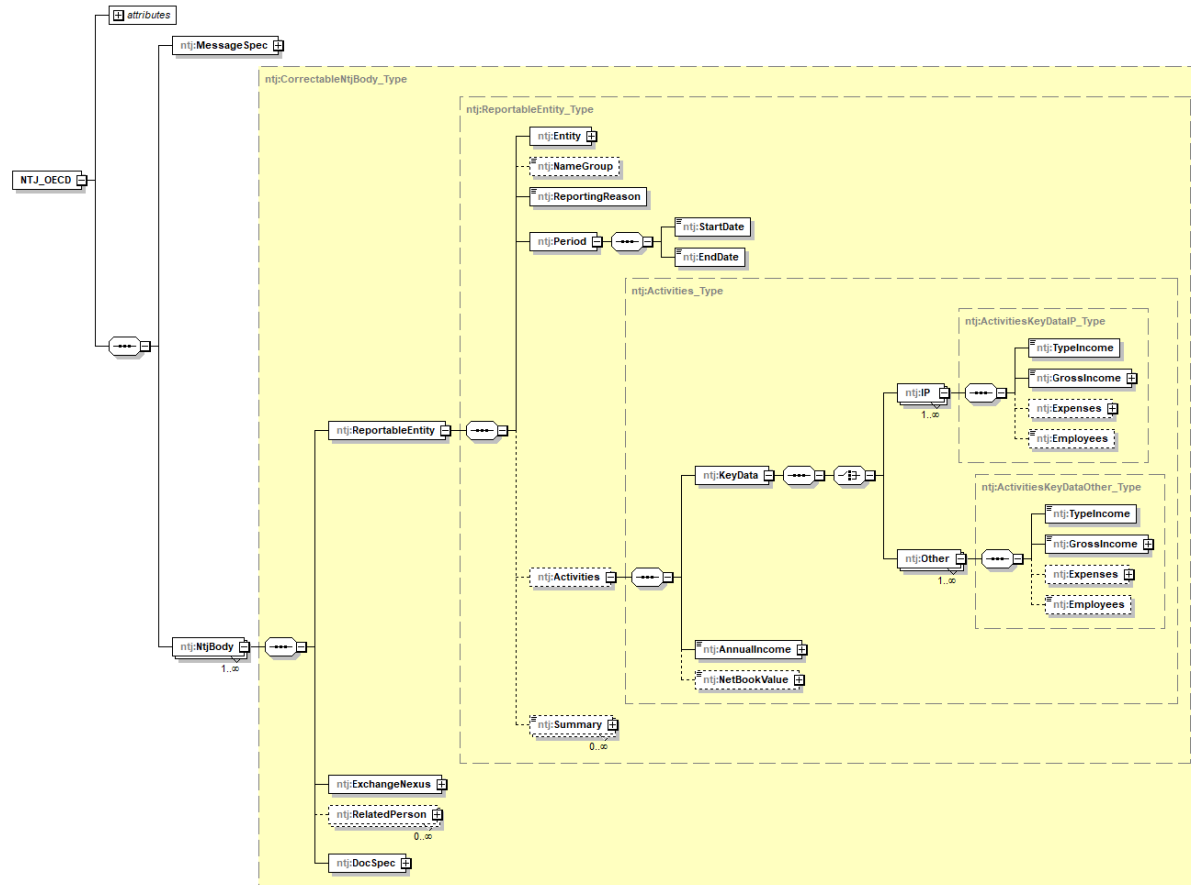

Generated by XMLSpy www.altova.com

Exchange nexus

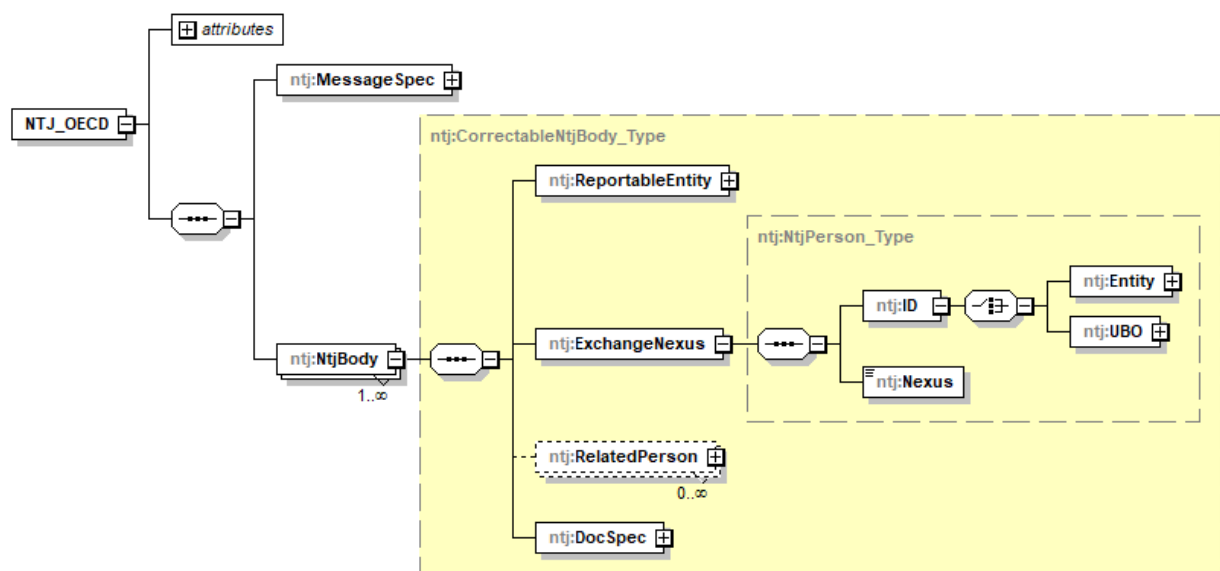

Generated by XMLSpy

www.altova.com

Organisation Party Type

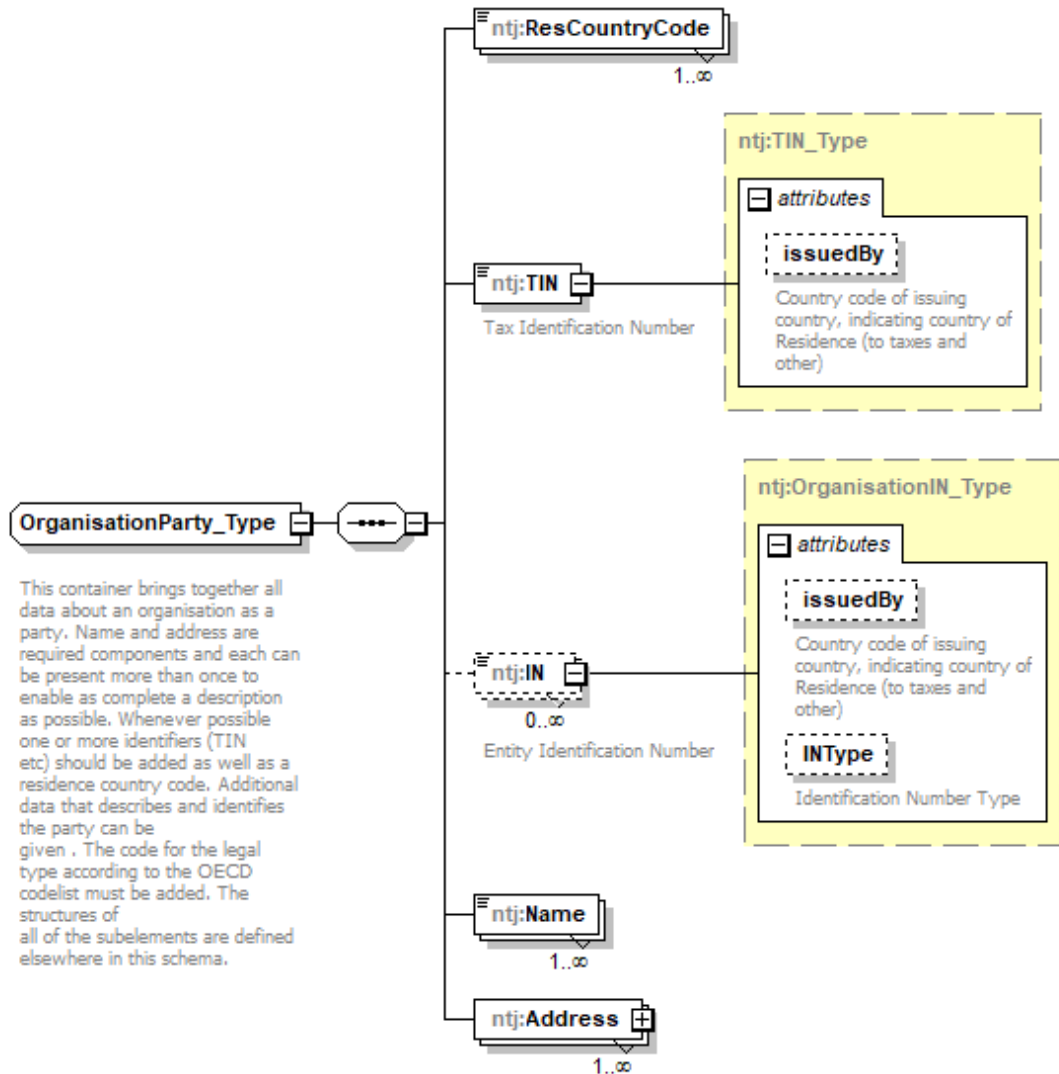

Generated by XMLSpy

www.altova.com

For practical reasons, the ResCountryCode list is based on the ISO 3166-1 country list which is currently used by banks and other financial institutions, and hence by tax administrations. The use of this list does not imply the expression by the OECD of any opinion whatsoever concerning the legal status of the territories listed. Its content is without prejudice to the status of or sovereignty over any territory, to the delimitation of international frontiers and boundaries and to the name of any territory, city or area.

Address Type

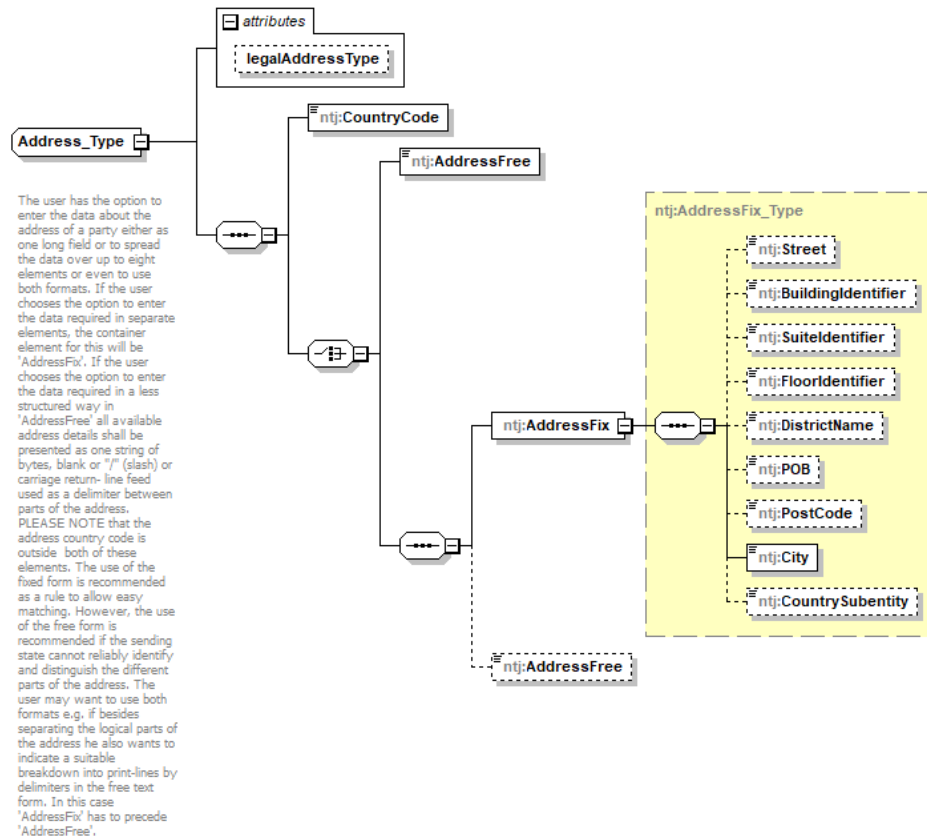

Generated by XMLSpy

www.altova.com

Person Type

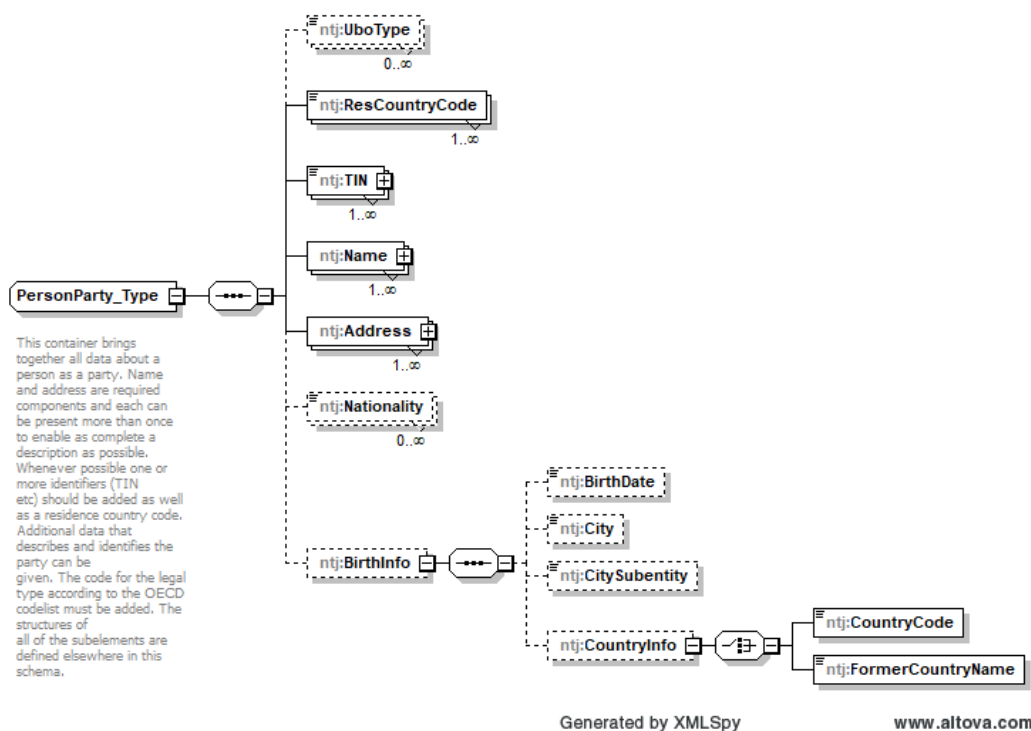

For practical reasons, the ResCountryCode list is based on the ISO 3166-1 country list which is currently used by banks and other financial institutions, and hence by tax administrations. The use of this list does not imply the expression by the OECD of any opinion whatsoever concerning the legal status of the territories listed. Its content is without prejudice to the status of or sovereignty over any territory, to the delimitation of international frontiers and boundaries and to the name of any territory, city or area.

Person Name Type

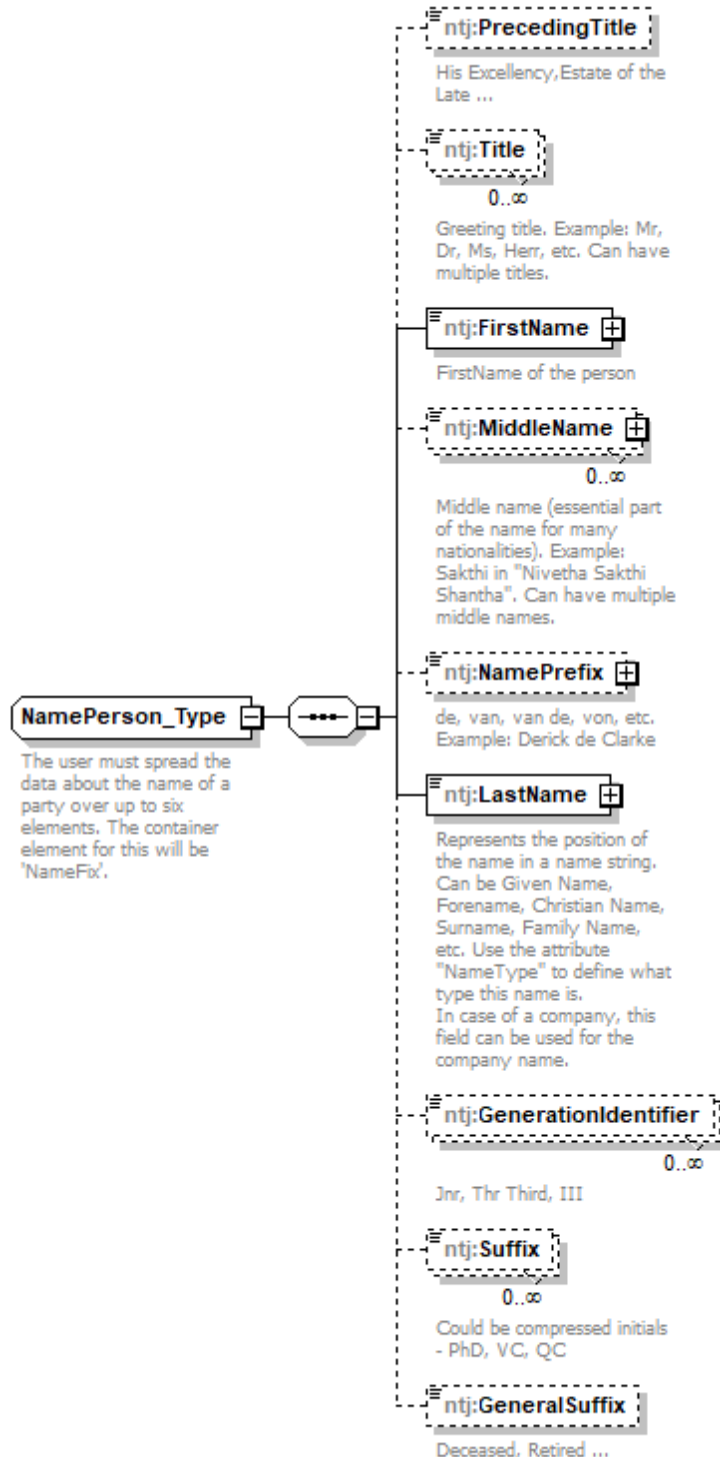

Generated by XMLSpy

www.altova.com

Annex B.

Glossary of Namespaces

NTJ XML Schema Namespaces

Namespace	Description	Filename
ntj	NTJ specific types	NtjXML_v1.0.xsd
stf	OECD Common types	OecdNtjTypes_v1.0.xsd
iso	ISO types(Country, Currency, Languages codes)	IsoNtjTypes_v1.0.xsd

Annex C. Template and instruction sheet for information exchange: cases of non-compliance (jurisdictions with a standard or a fully equipped monitoring mechanism)

All no or only nominal jurisdictions are required to exchange a full set of information on entities that have failed to meet the substantial activities requirements (cases of non-compliance).

1. Period to which the information relates

--

2. Identification of the entity and where appropriate the group of companies to which it belongs.

<i>Taxpayer identification number (TIN) or other identification reference number</i>		
<i>Legal name of the entity</i>		
<i>Address</i>	<i>Street</i>	
	<i>Building</i>	
	<i>Suite</i>	
	<i>Floor</i>	
	<i>District Name</i>	
	<i>Post Office Box</i>	
	<i>Post Code</i>	
	<i>City</i>	
	<i>Country</i>	

	<i>State/Province</i>	
<i>Name of group, if different</i>		

3. Details on relevant activities in respect of which the substance requirements have not been met. Please check the appropriate box (or boxes) and fill in the according amounts with an indication of the currency and the numbers of employees carrying out the concerned relevant activity.

<i>Type of income</i>		<i>Amount of gross income</i>	<i>Amount of operating expenses incurred</i>		<i>Number of full-time equivalent, qualified employees</i>
			<i>Directly incurred</i>	<i>Outsourcing expenditure</i>	
<i>Headquarters</i>	<input type="checkbox"/>				
<i>Financing and leasing</i>	<input type="checkbox"/>				
<i>Banking</i>	<input type="checkbox"/>				
<i>Insurance</i>	<input type="checkbox"/>				

<i>Distribution centre</i>	<input type="checkbox"/>				
<i>Services</i>	<input type="checkbox"/>				
<i>Shipping</i>	<input type="checkbox"/>				
<i>Holding</i>	<input type="checkbox"/>				
<i>Fund management</i>	<input type="checkbox"/>				
<i>IP</i>	<input type="checkbox"/>				
<i>Other (please specify)</i>	<input type="checkbox"/>				
<i>Gross total annual income of the entity</i>					
<i>Net book values of tangible assets held in the course of</i>					

<i>carrying out the business (total)</i>	
--	--

<i>Business premises (if different to address above)</i>	<i>Street</i>	
	<i>Building</i>	
	<i>Suite</i>	
	<i>Floor</i>	
	<i>District Name</i>	
	<i>Post Office Box</i>	
	<i>Post Code</i>	
	<i>City</i>	
	<i>Country</i>	
	<i>State/Province</i>	

4. Details of the entities/persons in the recipient jurisdiction(s).

	Name of entity/person	Address and jurisdiction of tax residence	TIN or other tax reference number, where available	Type of entity/person (indicate whether entity/person is immediate parent, ultimate parent or ultimate beneficial owner)
1.				

2.				
3.				
...				

5. Summary of which elements of the core income generating activities test the entity has failed to meet, and additional information if relevant. If the non-compliant entity is also a high risk scenario, and the exchange using the high risk template was not undertaken because the non-compliance was detected before the due date for exchange on high risk scenarios, please also include a breakdown of the type and amount of IP income (royalties, gain from sale of IP asset, other).

--

Annex D. Template and instruction sheet for information exchange: high risk scenarios (standard monitoring mechanism)

No or only nominal jurisdictions with a standard monitoring mechanism have to exchange detailed information in high risk scenarios as outlined below, except in years where information on an entity has already been exchanged in cases of non-compliance (See Annex C).

1. Period to which the information relates

--

2. Identification of the entity and where appropriate the group of companies to which it belongs.

<i>Taxpayer identification number (TIN) or other identification reference number</i>		
<i>Legal name of the entity</i>		
<i>Address</i>	<i>Street</i>	
	<i>Building</i>	
	<i>Suite</i>	
	<i>Floor</i>	
	<i>District Name</i>	
	<i>Post Office Box</i>	
	<i>Post Code</i>	
	<i>City</i>	
<i>Country</i>		

	<i>State/Province</i>	
<i>Name of group, if different</i>		

3. Details on relevant high risk IP activities. Please check the appropriate box (or boxes) and fill in the according amounts with an indication of the currency and the numbers of employees carrying out the concerned relevant activity.

<i>Type of income</i>		<i>Amount of gross income</i>	<i>Amount of operating expenses incurred</i>		<i>Number of full-time equivalent, qualified employees</i>
			<i>Directly incurred</i>	<i>Outsourcing expenditure</i>	
<i>Royalties</i>	<input type="checkbox"/>				
<i>Gains from sale of IP asset</i>	<input type="checkbox"/>				
<i>Other (please specify)</i>	<input type="checkbox"/>				
<i>Gross total annual income of the entity</i>					

<i>Net book values of tangible assets held in the course of carrying out the business (total)</i>	
---	--

<i>Business premises (if different to address above)</i>	<i>Street</i>	
	<i>Building</i>	
	<i>Suite</i>	
	<i>Floor</i>	
	<i>District Name</i>	
	<i>Post Office Box</i>	
	<i>Post Code</i>	
	<i>City</i>	
	<i>Country</i>	
	<i>State/Province</i>	

4. Details of the entities/persons in the recipient jurisdiction(s).

	Name of entity/person	Address and jurisdiction of tax residence	TIN or other tax reference number, where available	Type of entity/person (indicate whether entity/person is immediate parent, ultimate parent or ultimate beneficial owner)
1.				
2.				

3.				
...				

5. Summary of the core income generating activities, including whether and how the entity sought to rebut the presumption, and whether the authority agreed, and additional information if relevant. Relevant information to rebut the presumption would include a summary of a set of detailed information made available by the entity, such as detailed business plans, which demonstrate the commercial rationale for holding the IP assets in the jurisdiction; employee information, including level of experience, type of contracts, qualifications, and duration of employment; and evidence that decision making is taking place within the jurisdiction, rather than periodic decisions of non-resident board members.

Annex E. Template and instruction sheet for information exchange: high risk scenarios (fully equipped monitoring mechanism)

No or only nominal jurisdictions with a fully equipped monitoring mechanism have to exchange information in high risk scenarios as outlined below, except in years where information on an entity has already been exchanged in cases of non-compliance (See Annex C). The exchange on this information is designed as a two-step procedure and the information exchanged should allow the recipient jurisdiction to identify the concerned entity and to request in a second step additional information considered necessary.

1. Period to which the information relates

--

2. Identification of the entity and where appropriate the group of companies to which it belongs.

<i>Taxpayer identification number (TIN) or other identification reference number</i>		
<i>Legal name of the entity</i>		
<i>Address</i>	<i>Street</i>	
	<i>Building</i>	
	<i>Suite</i>	
	<i>Floor</i>	
	<i>District Name</i>	
	<i>Post Office Box</i>	
	<i>Post Code</i>	
<i>City</i>		

	<i>Country</i>	
	<i>State/Province</i>	
<i>Name of group, if different</i>		

3. Details on the relevant income. Please indicate the type of mobile income by checking the appropriate box (or boxes) and the gross income with an indication of the currency.

<i>Type of income</i>		<i>Amount of gross income</i>
<i>Royalties</i>	<input type="checkbox"/>	
<i>Gains from sale of IP asset</i>	<input type="checkbox"/>	
<i>Other (please specify)</i>	<input type="checkbox"/>	
<i>Gross total annual income of the entity</i>	<input type="checkbox"/>	

--	--	--

4. Details of the entities/persons in the recipient jurisdiction(s).

	Name of entity/person	Address and jurisdiction of tax residence	TIN or other tax reference number, where available	Type of entity/person (indicate whether entity/person is immediate parent, ultimate parent or ultimate beneficial owner)
1.				
2.				
3.				
...				

Annex F. Template and instruction sheet for information exchange: all other cases (standard monitoring mechanism)

No or only nominal jurisdictions with a standard monitoring mechanism have to exchange information on all entities engaged in the conduct of relevant activities, except in years where information on an entity has already been exchanged in cases of non-compliance (see Annex C) or cases of high risk (see Annex E). The exchange on this information is designed as a two-step procedure and the information exchanged should allow the recipient jurisdiction to identify the concerned entity and to request in a second step additional information considered necessary.

1. Period to which the information relates

--

2. Identification of the entity and where appropriate the group of companies to which it belongs.

<i>Taxpayer identification number (TIN) or other identification reference number</i>		
<i>Legal name of the entity</i>		
<i>Address</i>	<i>Street</i>	
	<i>Building</i>	
	<i>Suite</i>	
	<i>Floor</i>	
	<i>District Name</i>	
	<i>Post Office Box</i>	
	<i>Post Code</i>	

	<i>City</i>	
	<i>Country</i>	
	<i>State/Province</i>	
<i>Name of group, if different</i>		

3. Details on relevant activities. Please check the appropriate box (or boxes) and fill in the according amounts with an indication of the currency.

<i>Type of income</i>		<i>Amount of gross income</i>
<i>Headquarters</i>	<input type="checkbox"/>	
<i>Financing and leasing</i>	<input type="checkbox"/>	
<i>Banking</i>	<input type="checkbox"/>	
<i>Insurance</i>	<input type="checkbox"/>	
<i>Distribution centre</i>		

	<input type="checkbox"/>	
<i>Services</i>	<input type="checkbox"/>	
<i>Shipping</i>	<input type="checkbox"/>	
<i> Holding</i>	<input type="checkbox"/>	
<i>Fund management</i>	<input type="checkbox"/>	
<i>IP</i>	<input type="checkbox"/>	
<i>Other (please specify)</i>	<input type="checkbox"/>	
<i>Gross annual income (total)</i>		

4. Details of the entities/persons in the recipient jurisdiction(s).

	Name of entity/person	Address and jurisdiction of tax residence	TIN or other tax reference number, where available	Type of entity/person (indicate whether entity/person is immediate parent, ultimate parent or ultimate beneficial owner)
1.				
2.				
3.				
...				

Annex G. Opt-in notification template

NOTIFICATION ON THE SCOPE OF APPLICATION OF
THE EXCHANGE FRAMEWORK PURSUANT TO THE FHTP STANDARD
ON THE APPLICATION OF THE SUBSTANTIAL ACTIVITY FACTOR TO
NO OR ONLY NOMINAL TAX JURISDICTIONS

With respect to Articles 4 and 7 of the Convention on Mutual Administrative Assistance in Tax Matters, the Competent Authority of [JURISDICTION] notifies the Coordinating Body Secretariat of the following:

[JURISDICTION] confirms that, pursuant to Articles 4 and 7 of the Convention, it is in a position and interested to receive all information collected under the FHTP Standard [/....] ¹⁵ by

[List of NONOMS]

[List of NONOMS]

[List of NONOMS]

where

1. Immediate Parents are resident for tax purposes in [JURISDICTION], such information being foreseeably relevant to [JURISDICTION] in light of the following applicable legal provisions:

Legal provisions	
Narrative summary of the rules for which the information with respect to the substance of the Reportable Entities is foreseeably relevant	
Date the rules came into effect ¹⁶	

¹⁵ EU Member States wishing to receive additional information items agreed at an EU level can specify these here by including the following language: “full details with respect to all high-risk IP cases in all jurisdictions (regardless of a fully-equipped monitoring mechanism), as set out in the template in Annex C”.

¹⁶ The date on which the relevant rules came into effect only needs to be provided as part of the opt-in template in instances where the rules entered into effect after 1 January 2019.

[OR]

[JURISDICTION] does not wish to receive information collected under the FHTP Standard with respect to Immediate Parents resident for tax purposes in [JURISDICTION].

2. Ultimate Parents are resident for tax purposes in [JURISDICTION], such information being foreseeably relevant to [JURISDICTION] in light of the following applicable legal provisions:

Legal provisions	
Narrative summary of the rules for which the information with respect to the substance of the Reportable Entities is foreseeably relevant	
Date the rules came into effect	

[As part of the exchange with respect to Ultimate Parents, [JURISDICTION] also wishes to receive information with respect to Immediate Parents resident for tax purposes in other jurisdictions in light of the following applicable legal provisions:

Legal provisions	
Narrative summary of the rules for which the information with respect to the Immediate Parent of the Reportable Entities is foreseeably relevant	
Date the rules came into effect]	

[OR]

[JURISDICTION] does not wish to receive information collected under the FHTP Standard with respect to Ultimate Parents resident for tax purposes in [JURISDICTION].

3. Ultimate Beneficial Owners are resident for tax purposes in [JURISDICTION], such information being foreseeably relevant to [JURISDICTION] in light of the following applicable legal provisions:

Legal provisions	
Narrative summary of the rules for which the information with respect to the substance of the Reportable Entities is foreseeably relevant	

Date the rules came into effect	
---------------------------------	--

[As part of the exchange with respect to Ultimate Beneficial Owners, [JURISDICTION] also wishes to receive information with respect to Immediate Parents resident for tax purposes in other jurisdictions in light of the following applicable legal provisions:

Legal provisions	
Narrative summary of the rules for which the information with respect to the Immediate Parent of the Reportable Entities is foreseeably relevant	
Date the rules came into effect]	

[As part of the exchange with respect to Ultimate Beneficial Owners, [JURISDICTION] also wishes to receive information with respect to Ultimate Parents resident for tax purposes in other jurisdictions in light of the following applicable legal provisions:

Legal provisions	
Narrative summary of the rules for which the information with respect to the Ultimate Parent of the Reportable Entities is foreseeably relevant	
Date the rules came into effect]	

[OR]

[JURISDICTION] does not wish to receive information collected under the FHTP Standard with respect to Ultimate Beneficial Owners resident for tax purposes in [JURISDICTION].

4. Reportable Entities are tax resident in [JURISDICTION], such information being foreseeably relevant to [JURISDICTION] in light of the following applicable legal provisions:¹⁷

Legal provisions	
------------------	--

¹⁷ Where information on the tax residence of reportable entities in a jurisdiction other than the no or only nominal tax jurisdiction is also relevant for a jurisdiction which is the residence of the immediate parent, ultimate parent or ultimate beneficial owner of the reportable entities, the opt-in under points 1, 2 or 3 would be used to demonstrate this.

Narrative summary of the rules that ensure that the exchanged information meets the foreseeable relevance standard	
Date the rules came into effect	

[OR]

[JURISDICTION] does not wish to receive other information.

In submitting this notification, [JURISDICTION] confirms that it has the necessary confidentiality and data safeguards in place as assessed under Global Forum's AEOI standard to receive information specified in this notification by virtue of the Convention and pursuant to its Article 22.

[JURISDICTION] declares that as from [DATE] it is in a position to start receiving information specified in this notification in the agreed XML schema and through the OECD Common Transmission System.

This notification shall remain valid until the Competent Authority of [JURISDICTION] declares otherwise.

[NAME and TITLE]

For the Competent Authority of [JURISDICTION]



BETTER POLICIES FOR BETTER LIVES

For more information:

 ctp.beps@oecd.org

 <http://oe.cd/bepsaction5>

 [@OECDtax](https://twitter.com/OECDtax)